

Best.nr: 21-0091

# USB 3.0 Spectra™ 3022

2-Port USB 3.0 100m Multimode Fiber Extender System

## User Guide



Thank you for purchasing the USB 3.0 Spectra™ 3022.

Please read this guide thoroughly.

This document applies to Part Numbers: 00-00327, 00-00328, 00-00329, 00-00330 and 00-00371.

**FCC Radio Frequency Interference Statement Warning**

This device complies with Part 15 of the FCC rules. Operation is subject to the following two conditions: (1) this device may not cause harmful interference, and (2) this device must accept any interference received including interference that may cause undesired operation.

**CE Statement**

We, Icron Technologies Corporation, declare under our sole responsibility that the USB 3.0 Spectra 3022, to which this declaration relates, is in conformity with European Standard EN 55022, EN 61000 and EN 55024.

**IC Statement**

This Class B digital apparatus complies with Canadian ICES-003.

**WEEE Statement**

The European Union has established regulations for the collection and recycling of all waste electrical and electronic equipment (WEEE). Implementation of WEEE regulations may vary slightly by individual EU member states. Please check with your local and state government guidelines for safe disposal and recycling or contact your national WEEE recycling agency for more information.

**Product Operation and Storage**

Please read and follow all instructions provided with this product, and operate for intended use only. Do not attempt to open the product casing as this may cause damage and will void warranty. Use only the power supply provided with this product. When not in use, product should be stored in a dry location between -20°C and 70°C.

©2016 Icron Technologies Corporation. All rights reserved. Icron Technologies Corporation, the Icron Technologies Corporation logo, and the Icron Technologies Corporation products referred to herein are either the trademarks or the registered trademarks of Icron Technologies Corporation. All other trademarks are property of their respective owners. Icron Technologies Corporation assumes no responsibility for errors that may appear in this manual. Information contained herein is subject to change without notice.

# Contents

|  |           |
|--|-----------|
| <b>Introduction .....</b>                            | <b>3</b>  |
| Spectra 3022 Product Contents .....                  | 3         |
| About the USB 3.0 Spectra 3022 .....                 | 3         |
| The LEX Unit .....                                   | 4         |
| The REX Unit.....                                    | 5         |
| <b>Installation Guide .....</b>                      | <b>6</b>  |
| Requirements .....                                   | 6         |
| Fiber Optic Link Cabling.....                        | 6         |
| Installing the Spectra 3022 System.....              | 7         |
| Preparing Your Site .....                            | 7         |
| Preparing Your Computer.....                         | 7         |
| Connecting a USB 3.0 Device .....                    | 11        |
| Installing the LEX Unit .....                        | 11        |
| Installing the REX Unit .....                        | 12        |
| Checking the Installation .....                      | 12        |
| Compatibility .....                                  | 13        |
| <b>USB Extender Mounting Options .....</b>           | <b>14</b> |
| Option 1: USB Extender Mounting Kit .....            | 14        |
| Option 2: USB Extender Direct Surface Mounting ..... | 15        |
| <b>Troubleshooting .....</b>                         | <b>16</b> |
| <b>Contacting Technical Support .....</b>            | <b>18</b> |
| <b>Warranty Information .....</b>                    | <b>18</b> |
| <b>Obtaining Warranty Service .....</b>              | <b>19</b> |
| <b>Contacting Sales .....</b>                        | <b>19</b> |
| <b>Contacting Technical Support .....</b>            | <b>19</b> |
| <b>Specifications.....</b>                           | <b>20</b> |

## Introduction

This guide provides product information for the Spectra 3022, installation instructions, troubleshooting guidelines, and instructions for contacting Icron regarding technical support and warranty information.

The instructions in this guide assume a general knowledge of computer installation procedures, familiarity with cabling requirements, and some understanding of USB devices.

 NOTE: Notes provide additional information that could be useful.

 CAUTION: Cautions provide important information about an operational requirement.

## Spectra 3022 Product Contents

Your Spectra 3022 is packaged with:

- LEX (Local Extender)
- REX (Remote Extender)
- REX Locking AC power adapter
- USB 3.0 cable
- Country specific power cable
- Quick Start Guide and Warranty Information

## About the USB 3.0 Spectra 3022

The Spectra 3022 incorporates Icron's patented ExtremeUSB® technology, enabling users to extend beyond the approximate 3m cable limit for USB 3.0 peripheral devices. With the Spectra 3022, USB 3.0 devices can be located up to 100 meters from the computer. This extender system is composed of two individual units: the LEX unit and the REX unit.

 CAUTION: The Spectra 3022 supports only USB 3.0 devices. USB 2.0 and 1.1 devices will not function with this extender.

The Spectra 3022 includes the ExtremeUSB® suite of features:



- Transparent USB extension
- True plug and play; no software drivers required
- Works with all major operating systems: Windows®, OS X®, and Linux®

## The LEX Unit

The Local Extender (LEX) connects to the computer using a standard USB 3.0 cable. Power for this unit is provided by the USB on the host computer.

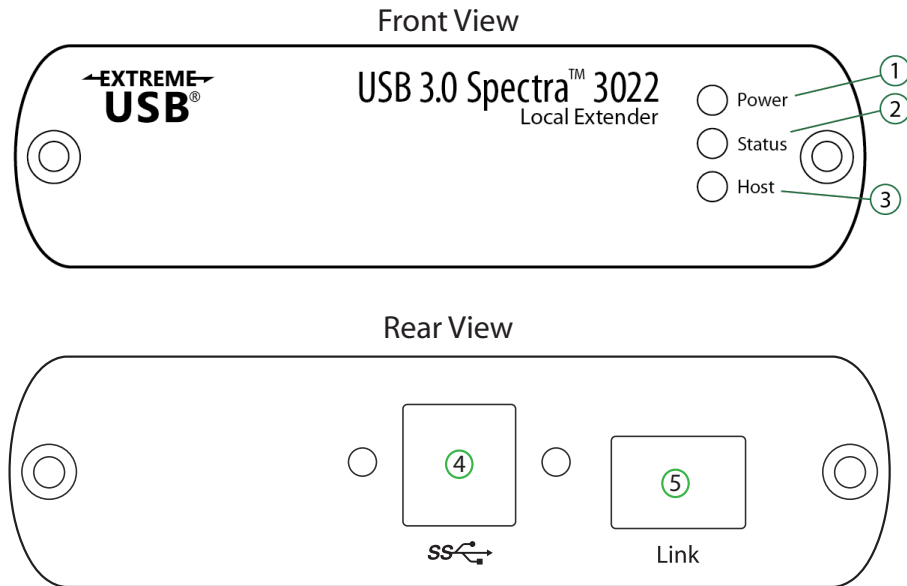

| ITEM | TYPE                  | DESCRIPTION  |
|------|-----------------------|--|
| 1    | Power ON              | Unit is powered properly.  |
|      | Power OFF             | Unit is not powered or not powered properly.   |
| 2    | Status Blinking       | Waiting for connection to REX.   |
|      | Status ON             | LEX/REX are linked and operating normally.   |
|      | Status OFF            | Fault detected; power cycle required.  |
| 3    | Host ON               | SuperSpeed Host detected on upstream facing port.  |
|      | Host OFF              | SuperSpeed Host not detected.  |
|      | Host Blinking         | SuperSpeed Host is suspended.  |
| 4    | USB 3.0 Type B port   | Used to connect the LEX to the host computer. Port accepts locking or non-locking USB 3.0 Type B connectors. (Read the message on the white sticker and remove sticker from the back of LEX before usage.) |
| 5    | Link Port (Duplex LC) | Extension link Duplex LC fiber optic transceiver port.   |

## The REX Unit

The Remote Extender (REX) provides USB Type A ports for USB 3.0 devices. The REX allows you to connect up to two USB 3.0 devices directly. The REX is powered by an external AC adapter and can supply up to 900mA to each USB port.

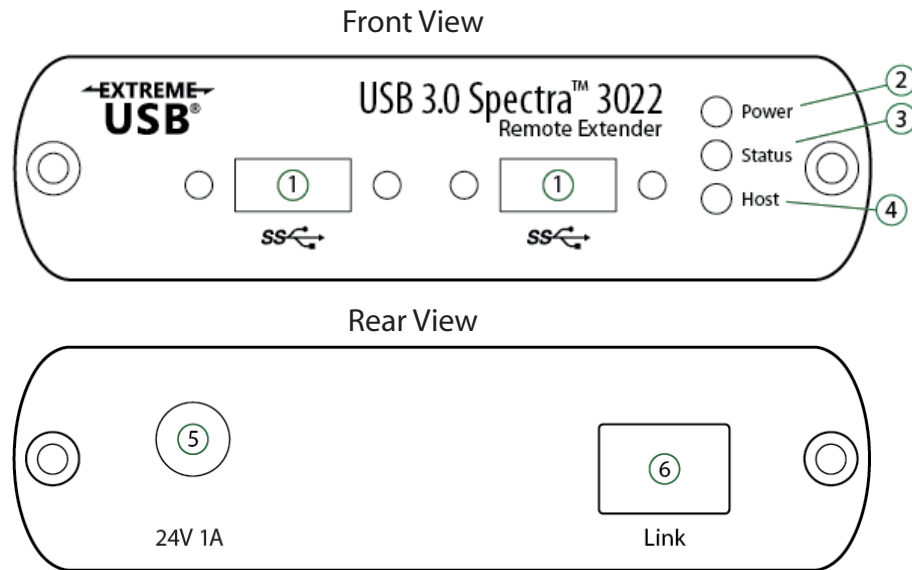

| ITEM | TYPE                  | DESCRIPTION  |
|------|-----------------------|--|
| 1    | USB 3.0 Type A ports  | Used to connect USB 3.0 device(s) to the REX. Ports accept locking or non-locking USB 3.0 Type A connectors. |
| 2    | Power ON              | Unit is powered properly.  |
|      | Power OFF             | Unit is not powered or not powered properly.   |
| 3    | Status Blinking       | Waiting for connection to LEX.   |
|      | Status ON             | LEX/REX are linked and operating normally.   |
|      | Status OFF            | Fault detected; power cycle required.  |
| 4    | Host ON               | SuperSpeed Host detected on upstream facing port.  |
|      | Host OFF              | SuperSpeed Host not detected.  |
|      | Host Blinking         | SuperSpeed Host is suspended.  |
| 5    | Power Port            | Connects to the locking AC power supply. Required on REX for proper operation.                               |
| 6    | Link Port (Duplex LC) | Extension link Duplex LC fiber optic transceiver port.   |

# Installation Guide

## Example Application

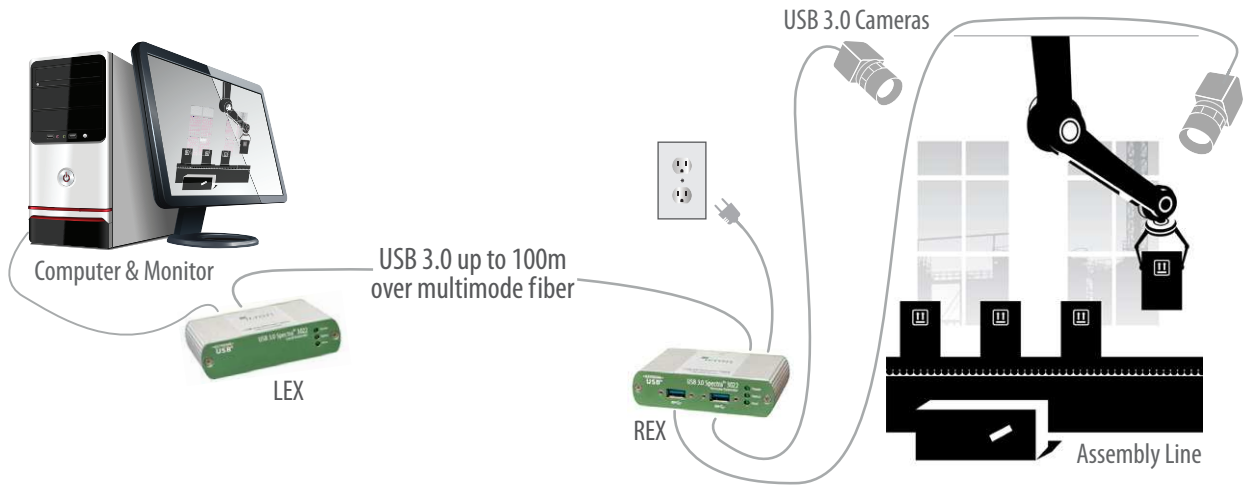

## Requirements

To complete installation of the Spectra 3022, you will also require the following items that are not included with the product:

- USB 3.0 compatible computer (host computer) with a USB 3.0 compliant operating system
- USB 3.0 compatible device
- 2-strand 50/125µm multimode (MMF) fiber optic cable with Duplex LC connectors

## Fiber Optic Link Cabling

The LEX and REX are interconnected by fiber optic cabling. This cabling must be:

- 50/125µm multimode fiber (MMF)
- Terminated with Duplex LC connectors

The following maximum distances are achievable depending upon the application and cabling standard:

| Multimode Fiber Class | Cameras | Storage |
|-----------------------|---------|---------|
| OM2                   | 50m     | 50m     |
| OM3                   | 100m    | 50m     |

Up to 50m with USB 3.0 storage type devices and up to 100m is achievable when using USB 3.0 bulk traffic cameras. For Microsoft Kinect applications, please use the SP3001-15 active extension cable.

**note** For assistance sourcing appropriate fiber optic cabling, contact [Icron Technical Support](#).

If premise cabling will be used for the installation, then the distances provided above must be met when measuring from LEX to REX, inclusive of the premise cabling and the patch cables. All cables must meet the ratings specified. Patch cables must be terminated with Duplex LC connectors.

# Installing the Spectra 3022 System

## Preparing Your Site

Before you can install the Spectra 3022, you need to prepare your site:

1. Determine where the computer is to be located and set up the computer.
2. Determine where you want to locate the USB device(s).
3. Ensure fiber optic cabling is in place, prepared, properly terminated, and within the maximum distances as defined for the cabling standard used.

## Preparing Your Computer

The Spectra 3022 does not support suspend modes of operation. As such, your computer should be configured to not go into “suspend mode” or to “suspend” the USB ports. Please refer to the instructions for your operating system listed below.

To perform the changes:

### Windows (7/8/8.1/10)

To disable “suspend” settings on your computer:

1. Open Control Panel. Open Power Options.

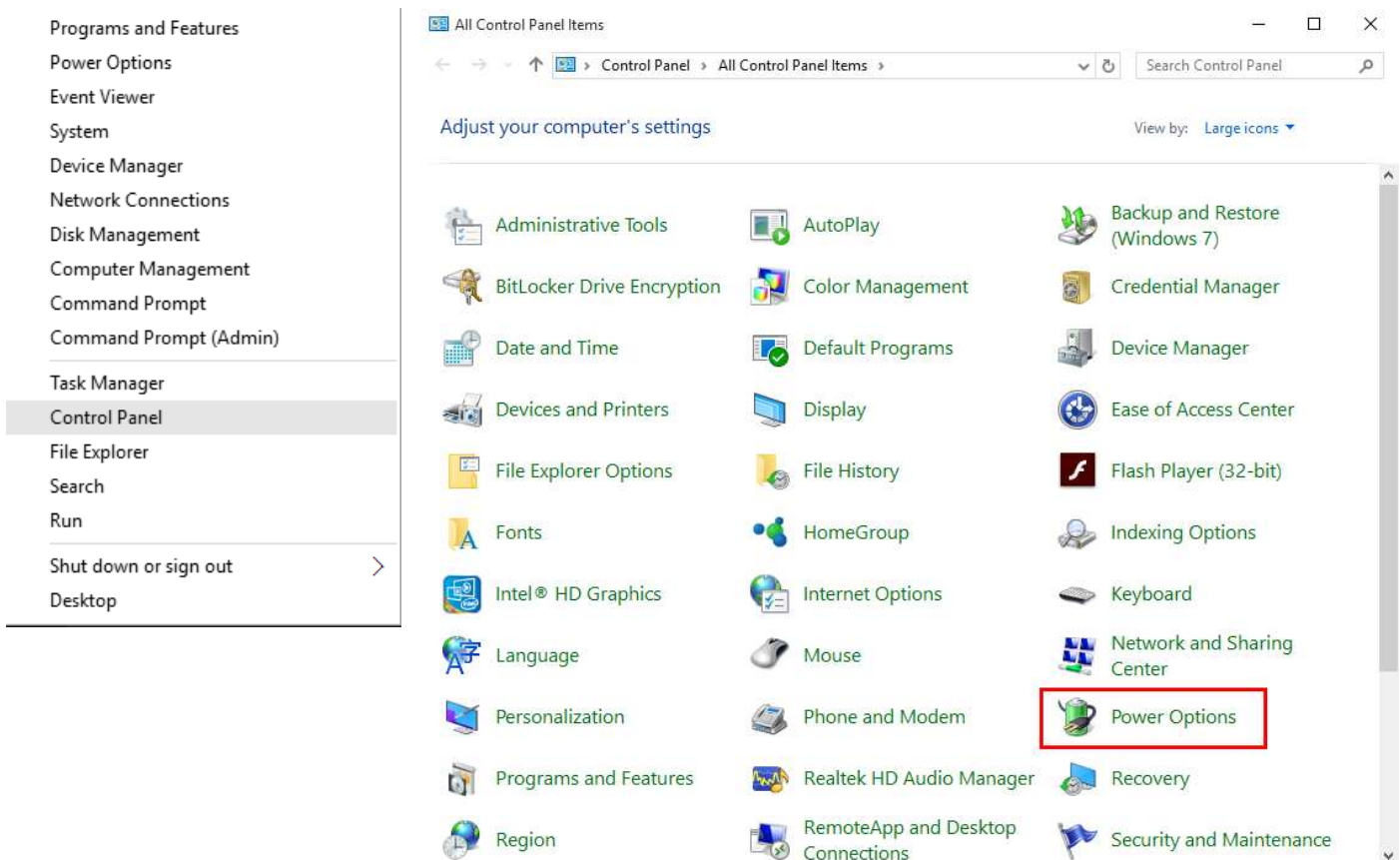



## a. Click on Change Plan Settings

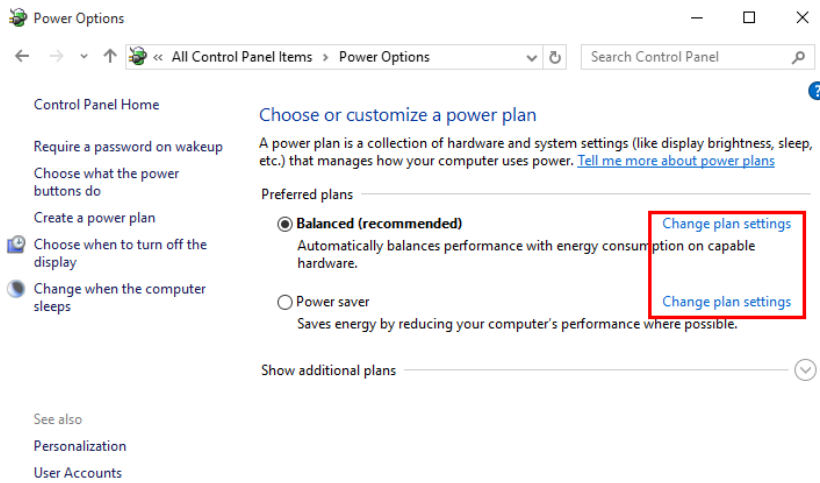

2. Select "Never" for "Put the computer to sleep" for all the configurations presented.
  - a. Click Change advanced power settings.

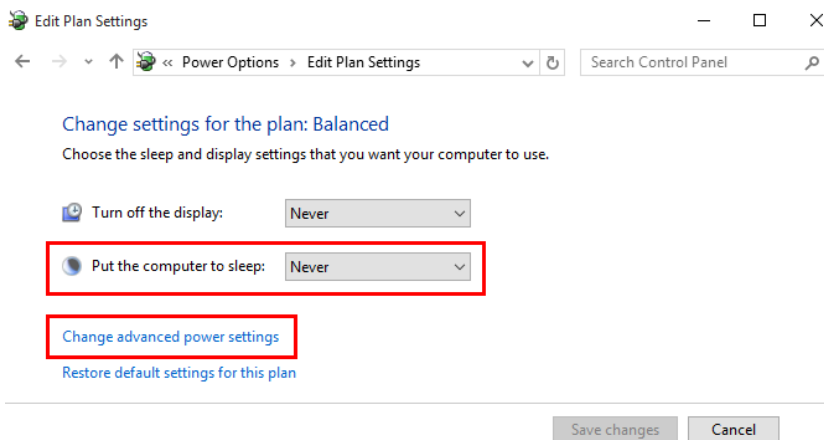

- b. Expand "USB settings"
    - c. Expand "USB selective suspend setting"
3. Select "Disabled".

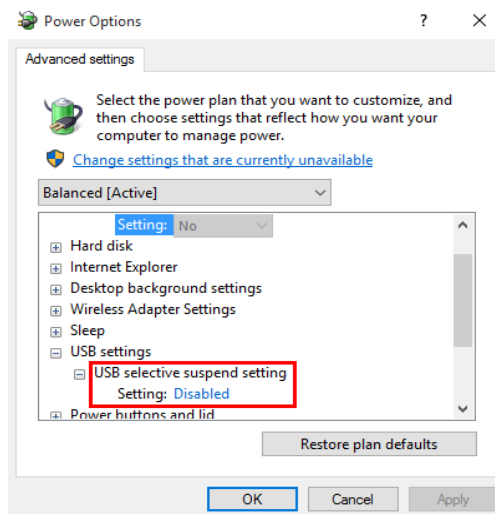

## OS X

To disable “suspend” settings on your computer:

1. Open System Preferences and select Energy Saver.

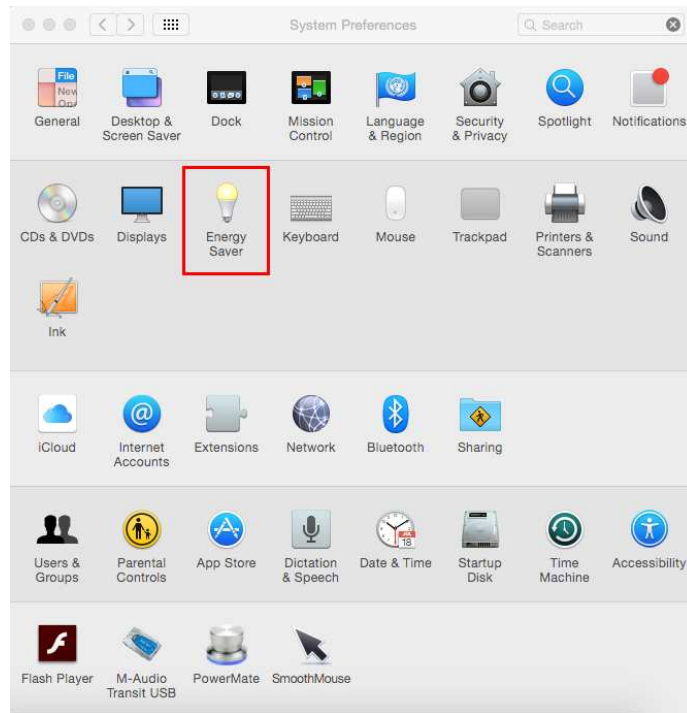

2. For both Battery and Power Adapter power settings, move slider bar to “Never” for “Computer Sleep”.

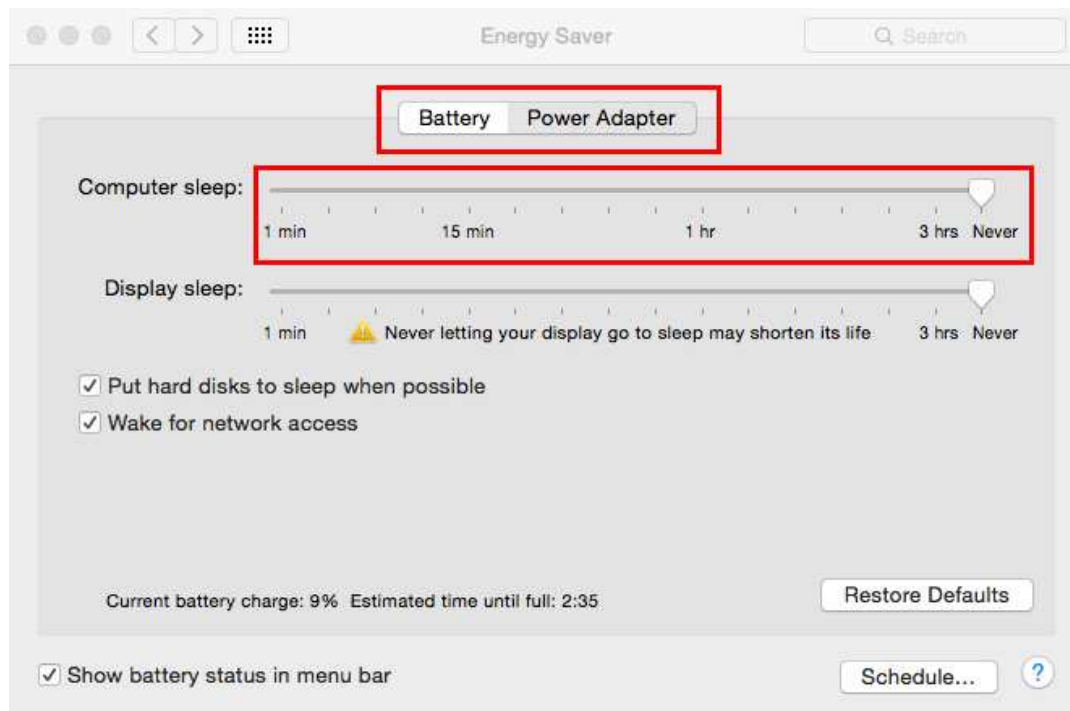

## Linux (Ubuntu 14.04)

To disable "suspend" settings on your computer:

1. Edit "/etc/default/grub" as root.
2. Append "usbcore.autosuspend=-1" (without quotations) to the GRUB\_CMDLINE\_LINUX\_DEFAULT variable.

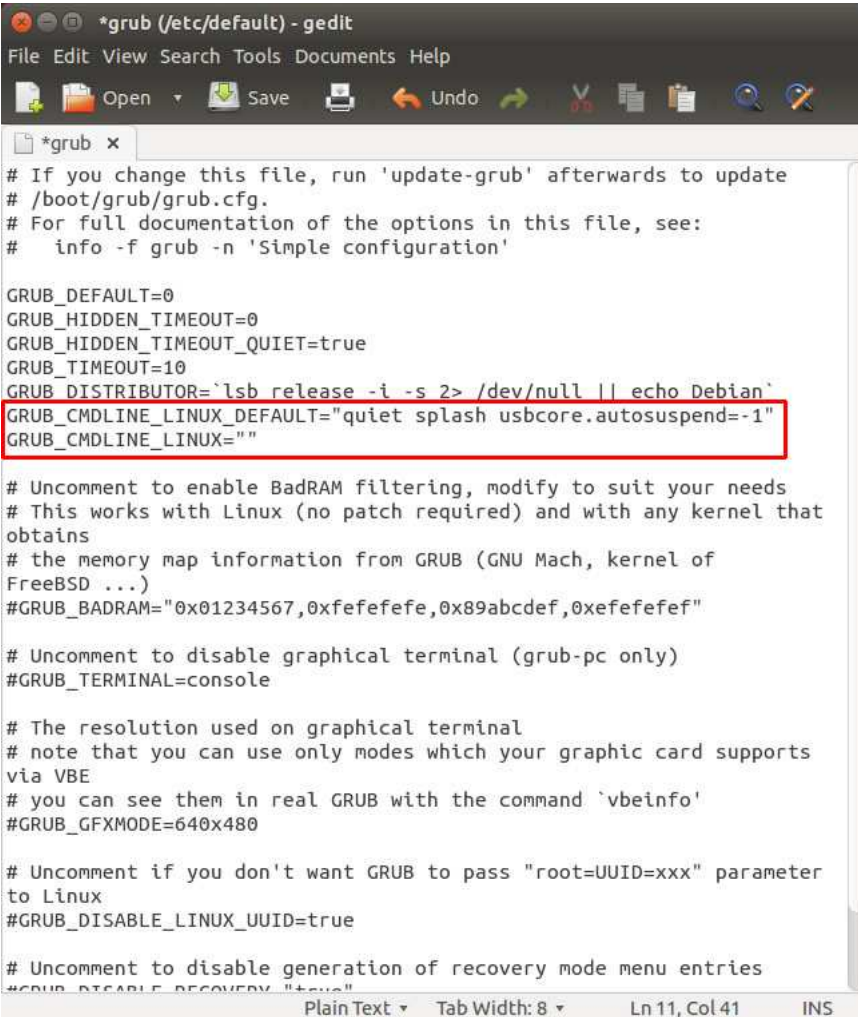

```
*grub (/etc/default) - gedit
File Edit View Search Tools Documents Help
Open Save Undo
*grub x
# If you change this file, run 'update-grub' afterwards to update
# /boot/grub/grub.cfg.
# For full documentation of the options in this file, see:
# info -f grub -n 'Simple configuration'

GRUB_DEFAULT=0
GRUB_HIDDEN_TIMEOUT=0
GRUB_HIDDEN_TIMEOUT_QUIET=true
GRUB_TIMEOUT=10
GRUB_DISTRIBUTOR=`lsb_release -i -s 2> /dev/null || echo Debian`
GRUB_CMDLINE_LINUX_DEFAULT="quiet splash usbcore.autosuspend=-1"
GRUB_CMDLINE_LINUX=""

# Uncomment to enable BadRAM filtering, modify to suit your needs
# This works with Linux (no patch required) and with any kernel that
# obtains
# the memory map information from GRUB (GNU Mach, kernel of
# FreeBSD ...)
#GRUB_BADRAM="0x01234567,0xfefefefe,0x89abcdef,0xefefefef"

# Uncomment to disable graphical terminal (grub-pc only)
#GRUB_TERMINAL=console

# The resolution used on graphical terminal
# note that you can use only modes which your graphic card supports
# via VBE
# you can see them in real GRUB with the command `vbeinfo'
#GRUB_GFXMODE=640x480

# Uncomment if you don't want GRUB to pass "root=UUID=xxx" parameter
# to Linux
#GRUB_DISABLE_LINUX_UUID=true

# Uncomment to disable generation of recovery mode menu entries
#GRUB_DISABLE_RECOVERY="true"
Plain Text Tab Width: 8 Ln 11, Col 41 INS
```

3. Run "update-grub" as root under ubuntu.
4. Reboot the host computer.

## Connecting a USB 3.0 Device

1. Install any software required to operate the USB device(s). Refer to the documentation for the USB device(s), as required.
2. Connect the USB device to the device port on the REX unit. If using an AIA USB3 Vision™ compliant locking USB cable, then turn the locking knobs to lock the cable to the port on the REX.

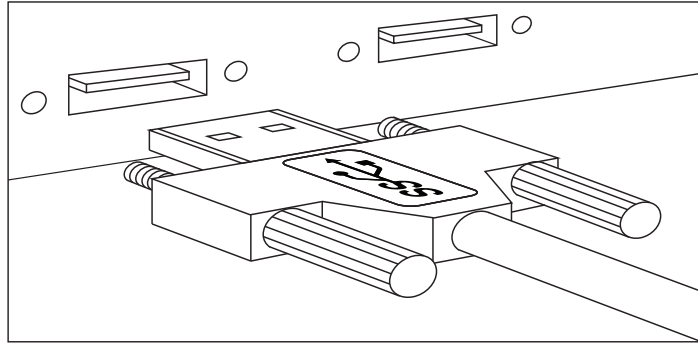

3. Check that the device is detected and installed properly in the operating system.

## Installing the LEX Unit

1. Remove the white sticker covering the USB 3.0 port that reads “Important Step: Disable Suspend settings on your computer prior to using this product”.
2. Ensure your computer’s suspend settings have been disabled (see the Preparing Your Computer section in the User Guide).
3. Place the LEX near the computer.
4. Connect the link cable to the LEX and the REX.

### With Surface Cabling

- Plug one end of the fiber optic cabling (not included) into the Link port on the LEX.
- Plug the other end of the fiber optic cabling into the Link port on the REX.

### With Premise Cabling

- Plug one end of a fiber optic patch cord (not included) into the Link port on the LEX.
- Plug the other end of the patch cord into the fiber optic information outlet near the host computer.
- Plug one end of the 2<sup>nd</sup> fiber optic patch cord (not included) into the Link port on the REX.
- Plug the other end of the 2<sup>nd</sup> patch cord into the fiber optic information outlet near the USB device.

5. Install the supplied USB 3.0 cable between the LEX and a USB 3.0 port on the host computer.

**!** CAUTION: The Spectra 3022 will not operate on a USB 2.0 port; please ensure you connect to a USB 3.0 port. USB 3.0 ports are blue whereas USB 2.0 ports are typically white or black.

## Installing the REX Unit

1. Place the REX near the USB device(s).
2. Plug the power adapter into a suitable AC outlet.
3. Connect the power adapter to the REX and twist the connector to lock the power connector into the REX.

## Checking the Installation

1. On the LEX and REX units, check that the Power, Status, and Host LEDs are on and solid. If the Host or Status LEDs are permanently off, then the cabling between the LEX and REX units may not be installed properly or is defective.
2. For Windows users, open Device Manager to confirm that the Spectra 3022 has installed correctly. Expand the entry for Universal Serial Bus controllers by clicking the “+” sign. If the Spectra 3022 has been installed correctly, you should find it listed as two “Generic SuperSpeed Hubs” or “3.0 Hubs”.

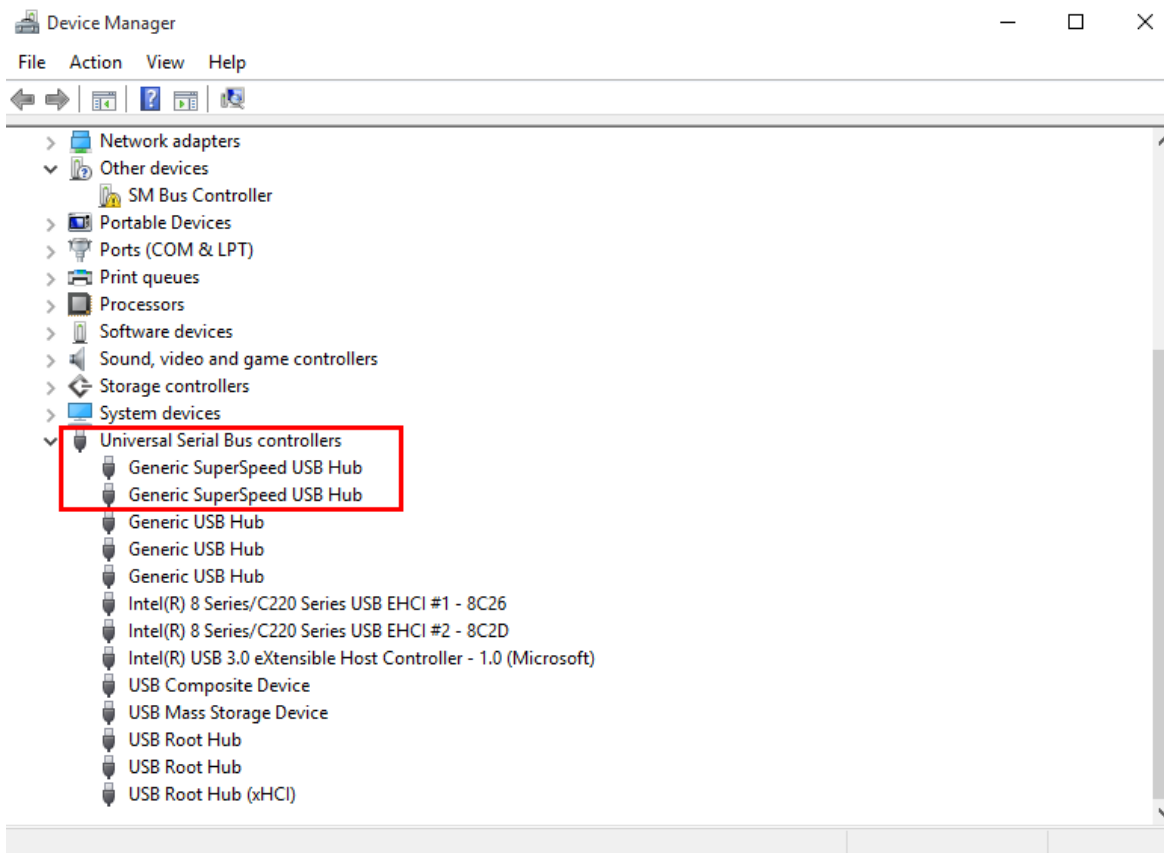

- For OS X users, open the System Profiler to confirm that the Spectra 3022 has installed correctly. In the left hand column under Hardware, select “USB” and inspect the right hand panel. If the Spectra 3022 has been installed correctly, you should find it listed as a “Hub” under the “USB 3.0 SuperSpeed Bus”.

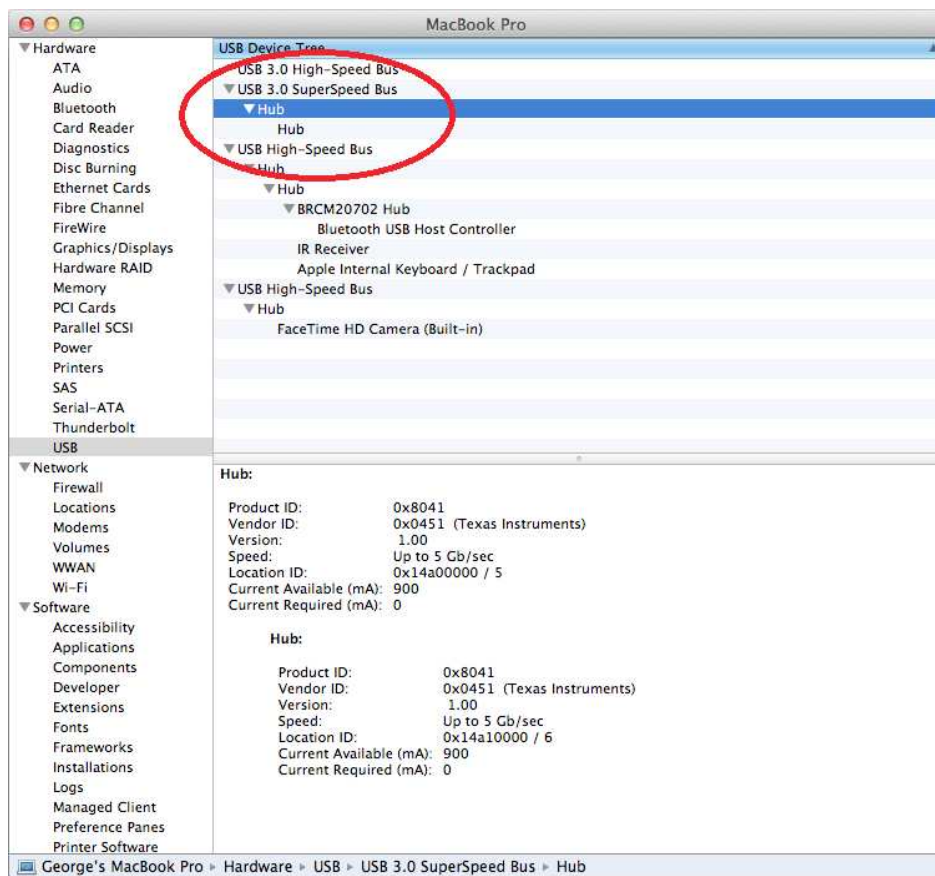

- For Linux users, plug in a USB 3.0 device into your Spectra 3022’s REX extender unit. Open a terminal and run the “lsusb” command. The extender should show up as a USB 3.0 hub device with a Vendor ID of 0000h and Product ID of 0000h.
- If the Spectra 3022 is not detected correctly or fails to detect, please consult the Troubleshooting section in this guide.



To open System Profiler in OS X: Open the Finder, select Applications, then open the Utilities folder and double click on the System Profiler icon.

To open Device Manager in Windows 10/8/8.1 or Windows 7:

Open the Start menu, right click on “Computer” then select: Manage >> Device Manager

## Compatibility

The Spectra 3022 complies with USB 3.0 specifications governing the design of USB devices. However, Icron does not guarantee that all USB 3.0 devices are compatible with the Spectra 3022, as there are a number of different configurations that may impact the operation of USB 3.0 devices over extended distances.

**!** CAUTION: The Spectra 3022 supports only USB 3.0 devices. USB 2.0 and 1.1 devices will not function through this extender.

## USB Extender Mounting Options

The bottom of the Spectra 3022 enclosures feature four convenient pre-drilled holes for optional mounting. Based on your requirements, choose from two available mounting options:

- 1. USB Extender Mounting Kit** (Purchased separately Order Part # 10-00406 USB Mounting Kit - Silver  
To locate a distributor/reseller in your area, visit: [icron.com/where-to-buy/](http://icron.com/where-to-buy/))
- 2. USB Extender Direct Surface Mounting** (Using your own hardware, stencil provided on page 15)

### OPTION 1: USB Extender Mounting Kit - each kit includes:

- 2 mounting brackets
- 4 (M3.0) locking washers
- 4 (M3.0 x 5mm) Phillips pan head screws
- Mounting bracket installation guide (*see diagram below*)

**note** 1 kit required to mount per LEX or REX, 2 kits required per Spectra 3022 extender system.

Using a Phillips screwdriver, in the order as illustrated below, fasten and secure the provided screws, locking washers and brackets into place.

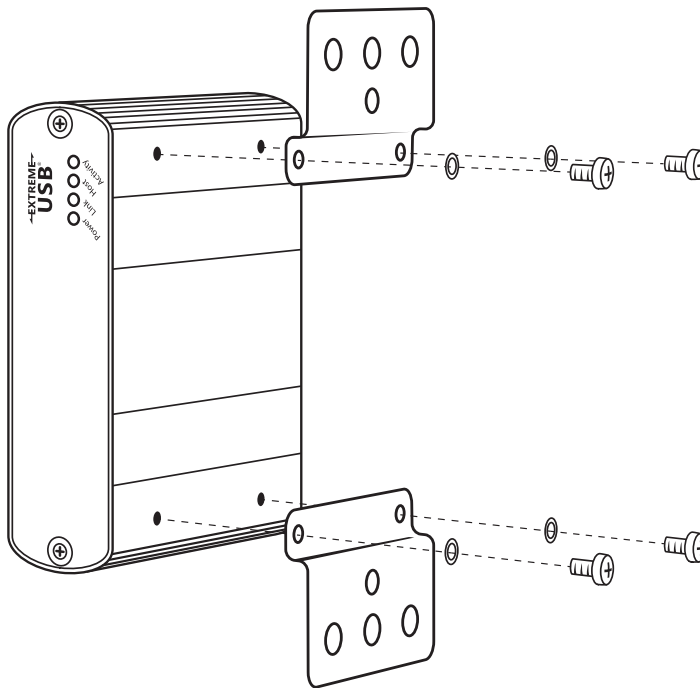

Once the bracket mounting is secured onto the extender, it is ready for mounting onto a surface. Please note you will need to provide your own screws to secure the extender using the available slots on each bracket.

## OPTION 2: USB Extender Direct Surface Mounting (using your own hardware)

The bottom of the Spectra 3022 enclosures features four pre-drilled holes for optional surface mounting.

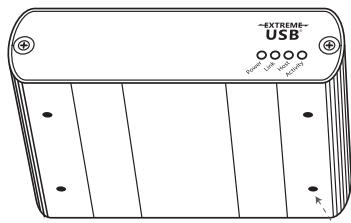

Distance between the enclosure mounting holes:  
42.0mm x 77.0mm

mounting hole

1. Mark the center point of each of the four holes on your mounting surface either by directly measuring or using a print out of the stencil below.
2. Hardware recommendation: M3.0 locking washers and M3.0 screws (4 of each per extender) noting screw length will depend upon thickness of mounting surface.
3. Drill through each of the four hole markings on the mounting surface using a 4.7625mm (3/16") drill bit.
4. Align the bottom enclosure holes to the newly drilled out holes on the mounting surface.
5. Place a locking washer on each of the four screws and using a screwdriver, fasten the extender into place.



To ensure the stencil below prints to scale be sure to set the page scaling setting to "none".

### Direct Surface Mounting Measurement Stencil

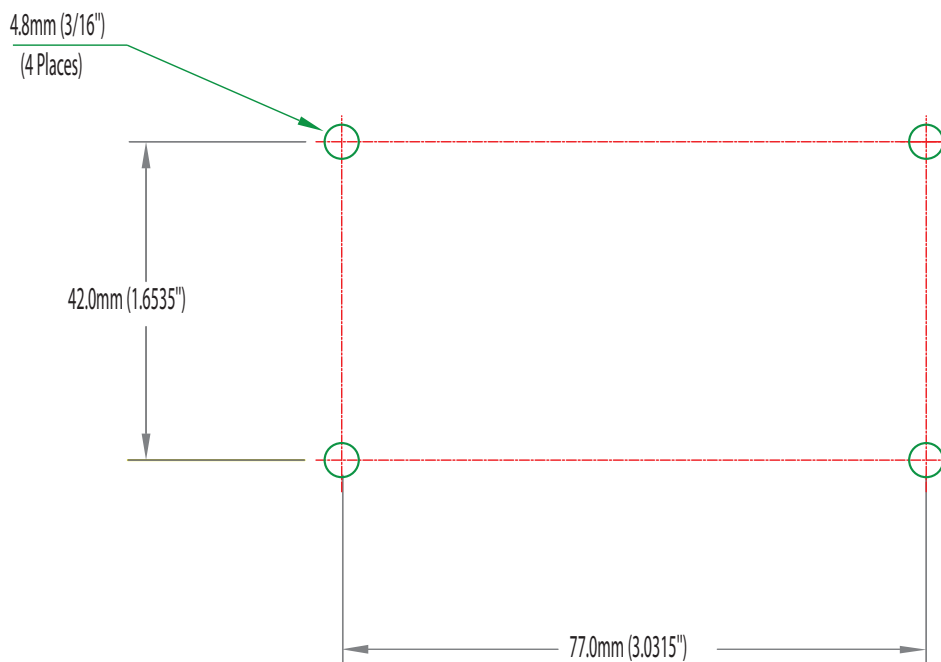



## Troubleshooting

The following table provides troubleshooting tips. The topics are arranged in the order in which they should be executed in most situations. If you are unable to resolve the problem after following these instructions, please contact [Technical Support](#) for further assistance.

| PROBLEM   | CAUSE  | SOLUTION   |
|---|--|--|
| All LEDs on LEX are off.                          | <ul style="list-style-type: none"> <li>The LEX is not receiving power from the USB port.</li> </ul>  | <ol style="list-style-type: none"> <li>Ensure that the USB connection between the LEX and host computer is properly installed.</li> <li>Move the USB connector to another USB port on the host computer.</li> </ol>  |
| All LEDs on REX are off.                          | <ul style="list-style-type: none"> <li>The REX is not receiving power from the AC adapter.</li> </ul>  | <ol style="list-style-type: none"> <li>Ensure that the AC power adapter is properly connected to the REX.</li> <li>Check that the AC adapter is connected to a live source of electrical power.</li> </ol>   |
| Status LEDs on both the LEX and REX are blinking. | <ul style="list-style-type: none"> <li>There is no connection between the LEX and REX.</li> <li>The LEX is not connected to a USB 3.0 port.</li> <li>The host computer does not support USB 3.0.</li> </ul>  | <ol style="list-style-type: none"> <li>Ensure that the host computer supports USB 3.0, refer to your computer's manual for confirmation.</li> <li>Ensure the LEX is connected to a USB 3.0 port. The centre of the port should be blue. Another colour, such as black usually indicates a USB 2.0 port.</li> <li>Ensure that a LC multimode fiber optic cable is connected between the LEX and REX.</li> <li>Connect a fiber optic patch cord between the LEX and REX. Recheck operation of the system.</li> </ol>   |
| Host LED is blinking on one or both units.        | <ul style="list-style-type: none"> <li>The computer went into suspend, hibernate or sleep mode.</li> <li>The computer tried to suspend the USB 3.0 port that is connected to the LEX.</li> </ul>   | <ol style="list-style-type: none"> <li>Follow the steps in "Preparing Your Computer" on page 7 to disable suspend modes on your computer. Refer to your operating system's manual for additional instructions if necessary.</li> <li>Power cycle the REX and the devices connected to the REX.</li> <li>Power cycle the LEX and REX, and the devices connected to the REX.</li> </ol>  |
| Host LED on LEX/REX is off.                       | <ul style="list-style-type: none"> <li>The host computer is not powered on.</li> <li>The LEX is not connected to the computer (when used with the optional LEX AC adapter).</li> <li>The LEX is not connected to a USB 3.0 host.</li> <li>The extender is malfunctioning.</li> </ul> | <ol style="list-style-type: none"> <li>Disconnect all USB devices from the REX.</li> <li>Disconnect the LEX from the computer.</li> <li>Disconnect the REX from the AC power adapter.</li> <li>Reconnect the LEX to the computer.</li> <li>Reconnect the REX to the AC power adapter.</li> <li>In the Universal Serial Bus controllers section of Device Manager, check that the Spectra 3022 is recognized as two "Superspeed Hubs" or two "3.0 Hubs".</li> <li>If problem persists, contact <a href="#">Technical Support</a> for assistance.</li> </ol> <p><b>note</b> It may be recognized as "Superspeed Hub", "3.0 Hub" or by other names, depending on the operating system and driver installed.</p> |

| <b>PROBLEM</b>   | <b>CAUSE</b>   | <b>SOLUTION</b>   |
|--|--|---|
| <p>All LEDs on both the LEX and REX are on but the USB device does not operate correctly, or is detected as an "Unknown Device" in the operating system.</p> | <ul style="list-style-type: none"> <li>• The USB device is malfunctioning.</li> <li>• The computer does not recognize the USB device.</li> <li>• The application software for the device is not operating.</li> <li>• The Spectra 3022 is malfunctioning.</li> </ul> | <ol style="list-style-type: none"> <li>1. Disconnect the Spectra 3022 from the computer.</li> <li>2. Connect the USB device directly to the USB port on the computer.</li> <li>3. If the USB device does not operate properly, consult the user documentation for the device.</li> <li>4. Update your system BIOS, chipset, or USB Host controller drivers from your System/Mother board manufacturer's website.</li> <li>5. If the USB device operates properly when directly connected to the computer, connect another device (of a different type) to the Spectra 3022. Connect the Spectra 3022 to the computer.</li> <li>6. If the second USB device does not operate, the Spectra 3022 may be malfunctioning. Contact <a href="#">Technical Support</a> for assistance.</li> <li>7. If the second USB device does operate properly, the first device may not be compatible with the Spectra 3022.</li> </ol> |
| <p>There are issues with the Microsoft Kinect and the Spectra 3022.</p>  | <ul style="list-style-type: none"> <li>• This extender is not fully compatible with the Kinect.</li> </ul>   | <ol style="list-style-type: none"> <li>1. Consider using the Spectra 3001-15 active extension cable.</li> </ol>   |

## Contacting Technical Support

If you are experiencing problems not referenced in the Troubleshooting section, contact **Icron Technical Support** at [icron.com/support](https://icron.com/support).

## Warranty Information

### Limited Hardware Warranty

Icron Technologies Corporation warrants that any hardware products accompanying this documentation shall be free from significant defects in material and workmanship for a period of **two years from the date of purchase**. Icron Technologies Corporation's hardware warranty extends to Licensee, its customers and end users.

The Warranty does not include repair of failures caused by: misuse, neglect, accident, modification, operation outside a normal operating environment, failure caused by service of the device by non-authorized servicers, or failure caused by a product for which Icron Technologies Corporation is not responsible. Opening the enclosures will void warranty.

### Hardware Remedies

Icron Technologies Corporation's entire liability and the Licensee's exclusive remedy for any breach of warranty, shall be, at Icron Technologies Corporation's option, either (a) return of the price paid or (b) repair or replacement of hardware, which will be warranted for the remainder of the original warranty period or 30 days, whichever is longer. These remedies are void if failure of the hardware has resulted from accident, abuse or misapplication.

### Limitation of Liability

The hardware warranty set forth in this agreement replaces all other warranties. Icron Technologies Corporation expressly disclaims all other merchantability and fitness for a particular purpose and noninfringement of third-party rights with respect to the hardware.

Icron Technologies Corporation dealer, agent or employee is not authorized to make any modification extension, or addition to this warranty. Under no circumstances will Icron Technologies Corporation, its suppliers or licensors be liable for any costs of procurement or substitute products or services, lost profits, loss of information or data, or any other special, indirect, consequential or incidental damages arising in any way out of the sale of, use of, or inability to use Icron Technologies Corporation product or service, even if Icron Technologies Corporation, its suppliers or licensors have been advised of the possibility of such damages. In no case shall Icron Technologies Corporation, its suppliers and licensors' liability exceed the actual money paid for the products at issue.

Since some jurisdictions do not allow the limitation of implied warranties of liability for incidental, consequential, special or indirect damages, the above limitation may not always apply. The above limitation will not apply in case of personal injury where and to the extent that applicable law requires such liability.

## Obtaining Warranty Service

To obtain warranty service, you must first contact Icron Technologies Corporation within the warranty period for a Return Material Authorization (RMA) number. Icron Technologies Corporation will not accept returns without an authorized RMA number. Be sure you have the serial numbers of the local extender and remote extender before calling. Package the product appropriately for safe shipment and mark the RMA number on the outside of the package. The package must be sent prepaid to Icron Technologies Corporation. We recommend that you insure it or send it by a method that provides for tracking of the package. The repaired or replaced item will be shipped to you, at Icron Technologies Corporation's expense, not later than thirty days after Icron Technologies Corporation receives the defective product.

Address the returning product to:

RMA Coordinator  
Icron Technologies Corporation  
4664 Lougheed Highway, Suite 221  
Burnaby, BC Canada  
V5C 5T5

## Contacting Sales

Email: [sales@icron.com](mailto:sales@icron.com)  
Tel: +1 604 638 3920

## Contacting Technical Support

[icron.com/support](http://icron.com/support)  
Tel: +1 604 638 3939

To help us serve you better, please include the following information with your technical support request:

- Host computer make and model
- Type of operating system installed (e.g. Windows 7, Windows 8, Windows 8.1, Windows 10, OS X, etc.)
- Part number and serial number of both the LEX and REX units
- Make and model of any USB device(s) attached to the Spectra 3022
- Description of the installation (Host PC model, transmission media used, and information on the USB devices)
- Description of the problem

## Specifications

| Distance*                        | <table border="1"> <thead> <tr> <th>Multimode Fiber Class</th> <th>Cameras</th> <th>Storage</th> </tr> </thead> <tbody> <tr> <td>OM2</td> <td>50m</td> <td>50m</td> </tr> <tr> <td>OM3</td> <td>100m</td> <td>50m</td> </tr> </tbody> </table> | Multimode Fiber Class | Cameras | Storage | OM2 | 50m | 50m | OM3 | 100m | 50m | * Up to 50m with USB 3.0 storage type devices and up to 100m is achievable when using USB 3.0 bulk traffic cameras. |
|----------------------------------|--|-----------------------|---------|---------|-----|-----|-----|-----|------|-----|---|
|                                  | Multimode Fiber Class  | Cameras               | Storage |         |     |     |     |     |      |     |   |
|                                  | OM2  | 50m                   | 50m     |         |     |     |     |     |      |     |   |
| OM3                              | 100m   | 50m                   |         |         |     |     |     |     |      |     |   |
| USB Device Support & Throughputs | USB 3.0 up to 5 Gbps (Not backward compatible with USB 2.0/1.1)  |                       |         |         |     |     |     |     |      |     |   |
| USB Host Support                 | xHCI Controllers (Intel, AMD, Renesas (NEC), Fresco, AsMedia)  |                       |         |         |     |     |     |     |      |     |   |
| Enclosure Material               | Anodized Aluminum  |                       |         |         |     |     |     |     |      |     |   |
| LEX (Local Extender)             |  |                       |         |         |     |     |     |     |      |     |   |
| USB Connector                    | 1 x USB 3.0 Type B Locking Receptacle per AIA USB3 Vision™ specification   |                       |         |         |     |     |     |     |      |     |   |
| Link Connector                   | 1 x Duplex LC Connector  |                       |         |         |     |     |     |     |      |     |   |
| Dimensions                       | 100mm x 76mm x 26mm (3.94" x 2.99" x 1.02")  |                       |         |         |     |     |     |     |      |     |   |
| REX (Remote Extender)            |  |                       |         |         |     |     |     |     |      |     |   |
| USB Connectors                   | 2 x USB 3.0 Type A Locking Receptacles per AIA USB3 Vision™ specification  |                       |         |         |     |     |     |     |      |     |   |
| Link Connector                   | 1 x Duplex LC Connector  |                       |         |         |     |     |     |     |      |     |   |
| Dimensions                       | 100mm x 76mm x 26mm (3.94" x 2.99" x 1.02")  |                       |         |         |     |     |     |     |      |     |   |
| Power Connector                  | 24V DC, 1A, Locking, 2.5 mm, center-positive   |                       |         |         |     |     |     |     |      |     |   |
| Available Current                | 900mA for each USB Port  |                       |         |         |     |     |     |     |      |     |   |
| Power Supply                     | 100-240V AC Brick, Locking   |                       |         |         |     |     |     |     |      |     |   |
| ENVIRONMENTAL                    |  |                       |         |         |     |     |     |     |      |     |   |
| Operating Temperature Range      | 0°C to 50°C (32°F to 122°F)  |                       |         |         |     |     |     |     |      |     |   |
| Storage Temperature Range        | -20°C to 70°C (-4°F to 158°F)  |                       |         |         |     |     |     |     |      |     |   |
| Operating Humidity               | 20% to 80% relative humidity, non-condensing   |                       |         |         |     |     |     |     |      |     |   |
| Storage Humidity                 | 10% to 90% relative humidity, non-condensing   |                       |         |         |     |     |     |     |      |     |   |
| COMPLIANCE                       |  |                       |         |         |     |     |     |     |      |     |   |
| EMC                              | FCC (Class B), CE (Class B)  |                       |         |         |     |     |     |     |      |     |   |
| Environmental                    | RoHS2 (CE)   |                       |         |         |     |     |     |     |      |     |   |
| Machine Vision                   | Works with AIA USB3 Vision™ compliant devices  |                       |         |         |     |     |     |     |      |     |   |
| SUPPORT                          |  |                       |         |         |     |     |     |     |      |     |   |
| Warranty                         | 2-year   |                       |         |         |     |     |     |     |      |     |   |

 icron

***DIREKTRONIK***

Direktronik AB tel. 08-52 400 700 [www.direktronik.se](http://www.direktronik.se)