



Temperature & Humidity Sensor

Featuring LoRaWAN[®]

EM320-TH

User Guide



Safety Precautions

Milesight will not shoulder responsibility for any loss or damage resulting from not following the instructions of this operating guide.

- ❖ The device must not be disassembled or remodeled in any way.
- ❖ In order to protect the security of the device, please change device password when first configuration. The default password is 123456.
- ❖ Do not place the device close to objects with naked flames.
- ❖ Do not place the device where the temperature is below/above the operating range.
- ❖ The device is not intended to be used as a reference sensor, and Milesight will not should responsibility for any damage which may result from inaccurate readings.
- ❖ The battery should be removed from the device if it is not to be used for an extended period. Otherwise, the battery might leak and damage the device. Never leave a discharged battery in the battery compartment.
- ❖ Make sure all batteries are newest when install, or battery life will be reduced.
- ❖ The device must never be subjected to shocks or impacts.

Declaration of Conformity

EM320-TH is in conformity with the essential requirements and other relevant provisions of the CE, FCC, and RoHS.

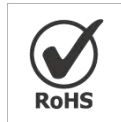

Copyright © 2011-2022 Milesight. All rights reserved.

All information in this guide is protected by copyright law. Whereby, no organization or individual shall copy or reproduce the whole or part of this user guide by any means without written authorization from Xiamen Milesight IoT Co., Ltd.

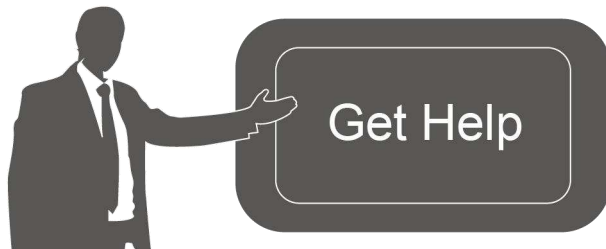

For assistance, please contact

Milesight technical support:

Email: iot.support@milesight.com

Support portal: support.milesight-iot.com

Tel: 86-592-5085280

Fax: 86-592-5023065

Address: Building C09, Software Park III,
Xiamen 361024, China

Revision History

Date	Doc Version	Description
Oct.13, 2022	V 1.0	Initial version

Contents

1. Product Introduction	5
1.1 Overview	5
1.2 Features	5
2. Hardware Introduction	6
2.1 Packing List	6
2.2 Hardware Overview	6
2.3 Dimensions	6
3. Operation Guide	7
3.1 NFC Configuration	7
3.2 LoRaWAN Settings	8
3.3 Basic Settings	11
3.4 Advanced Settings	11
3.4.1 Calibration Settings	11
3.4.2 Threshold Settings	12
3.4.3 Data Storage	12
3.4.4 Data Retransmission	14
3.5 Maintenance	15
3.5.1 Upgrade	15
3.5.2 Backup	16
3.5.3 Reset to Factory Default	17
4. Installation	18
5. Device Payload	19
5.1 Basic Information	19
5.2 Sensor Data	19
5.3 Downlink Commands	20
5.4 Historical Data Enquiry	21

1. Product Introduction

1.1 Overview

EM320-TH is a simple, compact and powerful LoRaWAN® temperature & humidity sensor. It is equipped with high-precision sensors and IP67 waterproof design, applicable for accurate temperature and humidity data detection in various harsh environments. FDA-approved food-grade material's enclosure and magnet design allow it to be placed in freezers and refrigerators and in contact with food or medicines safely. Two optional versions can unleash the potential of EM320-TH sensor to the maximum.

In addition to LoRaWAN® technology with low power consumption, it has built-in high-capacity batteries available for usage for up to 5 years without battery replacement. Moreover, EM320-TH is compatible with both Milesight LoRaWAN® Gateway and Milesight IoT Cloud to achieve remote data monitoring and management. It is suitable for both indoor and outdoor applications such as cold chain transportation, agricultural greenhouse, office buildings, hospitals, factories, etc.

1.2 Features

- Uses high-precision sensor, capable of sensor subtle changes in temperature and humidity
- IP67 waterproof enclosure with multi-level structure and sealing ring design enabling strong waterproof performance for harsh environments
- Uses FDA-approved food-grade material's enclosure, which is safe for contact with food or medicines
- Ultra-low power consumption and standby with 5400mAh built-in replaceable batteries, ensuring durable battery life
- Wall mounting or magnet version optional for multiple installation scenarios
- Anti-theft and anti-slip pad design on back cover to secure firm and sturdy installation
- Long range data transmission for up to 15 kilometers in rural areas
- Store locally 3000 historical records and support retransmission to prevent data loss
- Equipped with NFC for easy configuration
- Compliant with standard LoRaWAN® gateways and network servers
- Quick and easy management with Milesight IoT Cloud solution

2. Hardware Introduction

2.1 Packing List

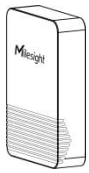

1 × EM320-TH
Sensor



1 × Quick Start
Guide



1 × Warranty
Card

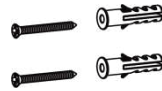

2 × Wall
Mounting Kits
(Standard Version Only)



1 × Fixing
Screw(Standard
Version Only)

⚠ If any of the above items is missing or damaged, please contact your sales Representative.

2.2 Hardware Overview

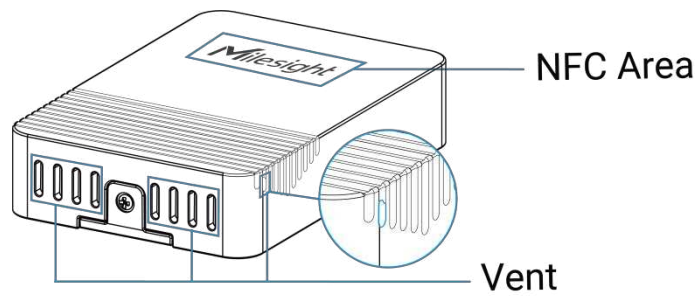

2.3 Dimensions(mm)

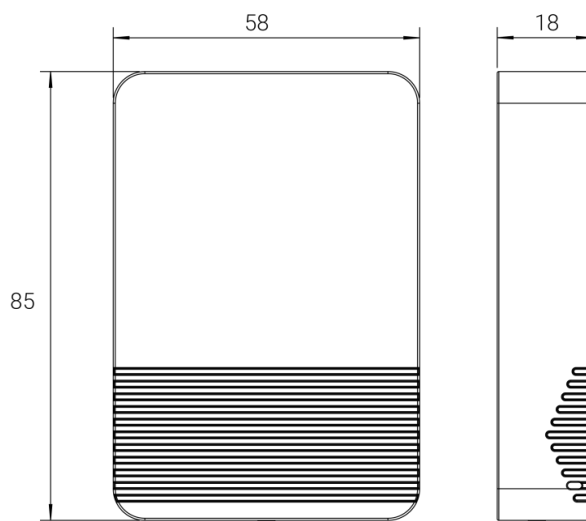

2.4 Power Button

The LED indicator and power button are inside the device. Switch on/off and reset can also be configured via NFC.

Function	Action	LED Indication
Turn On	Press and hold the button for more than 3 seconds.	Off → On
Turn Off	Press and hold the button for more than 3 seconds.	On → Off
Reset	Press and hold the button for more than 10 seconds.	Blink 3 times.
Check On/Off Status	Quickly press the power button.	Light On: Device is on. Light Off: Device is off.

3. Operation Guide

3.1 NFC Configuration

EM320-TH sensor can be monitored and configured via NFC. Please refer the following steps to complete configuration.

1. Download and install “Milesight ToolBox” App from Google Play or Apple App Store.
2. Enable NFC on the smartphone and launch Milesight ToolBox.
3. Attach the smartphone with NFC area to the device to read device information. Basic information and settings of the device will be shown on ToolBox App if it's recognized successfully. You can read and configure the device by tapping the Read/Write device on the App. In order to protect the security of the device, please change password when first configuration. The default password is **123456**.

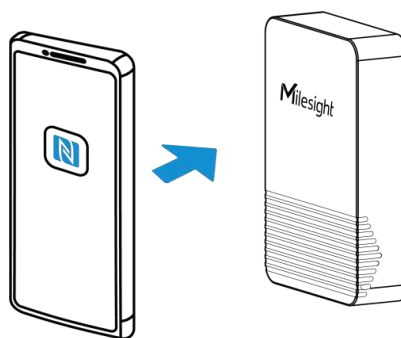

Note:

- 1) Ensure the location of smartphone NFC area and it's recommended to take off phone case.
- 2) If the smartphone fails to read/write configurations via NFC, keep the phone away and back to try again.
- 3) EM320-TH sensor can also be configured by dedicated NFC reader, which can be purchased from Milesight IoT.

3.2 LoRaWAN Settings

LoRaWAN settings is used for configuring the transmission parameters in LoRaWAN® network.

Basic LoRaWAN Settings:

Go to “**Device -> Settings -> LoRaWAN Settings**” of ToolBox App to configure join type, App EUI, App Key and other information. You can also keep all settings by default.

Device EUI

* APP EUI

* Application Port 85

Join Type

* Application Key

LoRaWAN Version

Work Mode

Confirmed Mode

Rejoin Mode

Set the number of detection signals sent

ADR Mode

Spreading Factor

TXPower

Parameters	Description
Device EUI	Unique ID of the device which can also be found on the label.
App EUI	Default App EUI is 24E124C0002A0001.
Application Port	The port is used for sending and receiving data, default port is 85.
Join Type	OTAA and ABP mode are available.
Application Key	Appkey for OTAA mode, default is 5572404C696E6B4C6F52613230313823.
Device Address	DevAddr for ABP mode, default is the 5 th to 12 th digits of SN.
Network Session Key	Nwkskey for ABP mode, default is 5572404C696E6B4C6F52613230313823.
Application Session Key	Appskey for ABP mode, default is 5572404C696E6B4C6F52613230313823.
LoRaWAN Version	V1.0.2, V1.0.3, V1.1 are available.
Work Mode	It's fixed as Class A.
RX2 Data Rate	RX2 data rate to receive downlinks.
RX2 Frequency	RX2 frequency to receive downlinks. Unit: Hz
Spread Factor	If ADR is disabled, the device will send data via this spread factor.
Confirmed Mode	If the device does not receive ACK packet from network server, it will resend data once.
Rejoin Mode	Reporting interval \leq 30 mins: the device will send a specific number of LinkCheckReq MAC packets to the network server every 30 mins to validate connectivity; If there is no response, the device will re-join the network. Reporting interval $>$ 30 mins: the device will send a specific number of LinkCheckReq MAC packets to the network server every reporting interval to validate connectivity; If there is no response, the device will re-join the network.
Set the number of packets sent	When rejoin mode is enabled, set the number of LinkCheckReq packets sent.
ADR Mode	Allow network server to adjust datarate of the device.
Tx Power	Transmit power of the device.

Note:

- 1) Please contact sales for device EUI list if there are many units.
- 2) Please contact sales if you need random App keys before purchase.
- 3) Select OTAA mode if you use Milesight IoT cloud to manage devices.
- 4) Only OTAA mode supports rejoin mode.

LoRaWAN Frequency Settings:

Go to “Settings -> LoRaWAN Settings” of ToolBox App to select supported frequency and select channels to send uplinks. Make sure the channels match the LoRaWAN® gateway.

* Support Frequency

EU868

868.1

868.3

868.5

863

If frequency is one of CN470/AU915/US915, you can enter the index of the channel that you want to enable in the input box, making them separated by commas.

Examples:

- 1, 40: Enabling Channel 1 and Channel 40
- 1-40: Enabling Channel 1 to Channel 40
- 1-40, 60: Enabling Channel 1 to Channel 40 and Channel 60
- All: Enabling all channels
- Null: Indicates that all channels are disabled

* Support Frequency

AU915

Enable Channel Index ⓘ

8-15

Index	Frequency/MHz ⓘ
0 - 15	915.2 - 918.2
16 - 31	918.4 - 921.4
32 - 47	921.6 - 924.6
48 - 63	924.8 - 927.8
64 - 71	915.9 - 927.1

Note:

For -868M model, the default frequency is EU868;

For -915M model, the default frequency is AU915.

3.3 Basic Settings

Go to “**Device -> Settings -> General Settings**” of ToolBox App to change the reporting interval, etc.

Temperature Unit ⓘ
 °C

Reporting Interval - 10 + min

Data Storage ⓘ

Data Retransmission ⓘ

Change Password

Parameters	Description
Reporting Interval	Reporting interval of transmitting current sensor values to network server. Default: 10 mins, Range: 1-1080 mins
Temperature Unit	Change the temperature unit displayed on the ToolBox. Note: 1) The temperature unit in the reporting package is fixed as °C. 2) Please modify the threshold settings if the unit is changed.
Data Storage	Disable or enable data storage locally. (see section 3.4.3 to export data)
Data Retransmission	Disable or enable data retransmission. (see section 3.4.4)
Change Password	Change the password for ToolBox App or software to read/write this device.

3.4 Advanced Settings

3.4.1 Calibration Settings

ToolBox supports numerical calibration for all items. Go to “**Device -> Settings -> Data Collection Settings**” of ToolBox App to type the calibration value and save, the device will add the calibration value to raw value.

Temperature**Numerical Calibration**

Current Value: 29.5 °C

Calibration Value

°C

Final Value: 29.5 °C

Humidity

3.4.2 Threshold Settings

Go to “**Device -> Settings -> Threshold Settings**” of ToolBox App to enable the threshold settings and input the threshold, it will upload the current data once instantly when temperature is over or below the threshold. Note that when you change the temperature unit, please re-configure the threshold.

Temperature

Over / °C

Below / °C

Collecting Interval 10 min

3.4.3 Data Storage

EM320-TH sensor supports storing more than 3000 data records locally and exports data via ToolBox App. The device will record the data according to reporting interval even not joining network.

1. Go to “**Device -> Settings -> General Settings**” of ToolBox App to enable data storage feature.
2. Go to “**Device -> Maintenance**” of ToolBox App, click “**Export**”, then select the data time range and click “**Confirm**” to export data. ToolBox App can export last 7 days’ data at most.

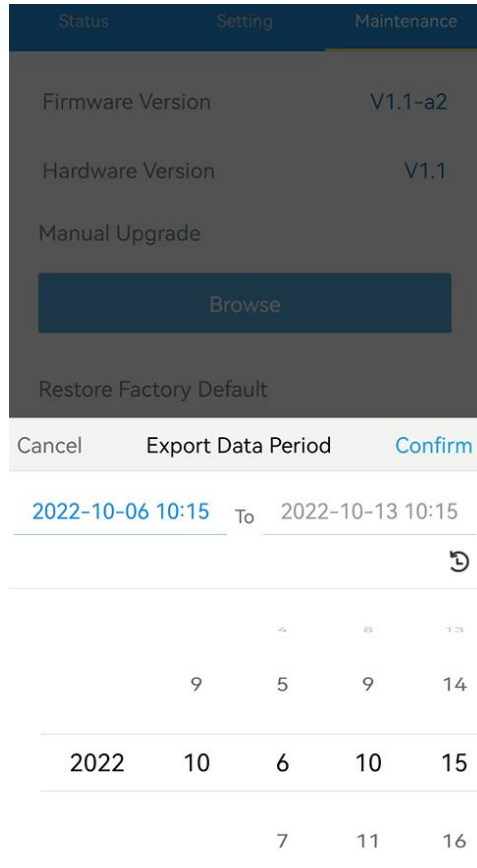

3. Click "Data Cleaning" to clear all stored data inside the device.

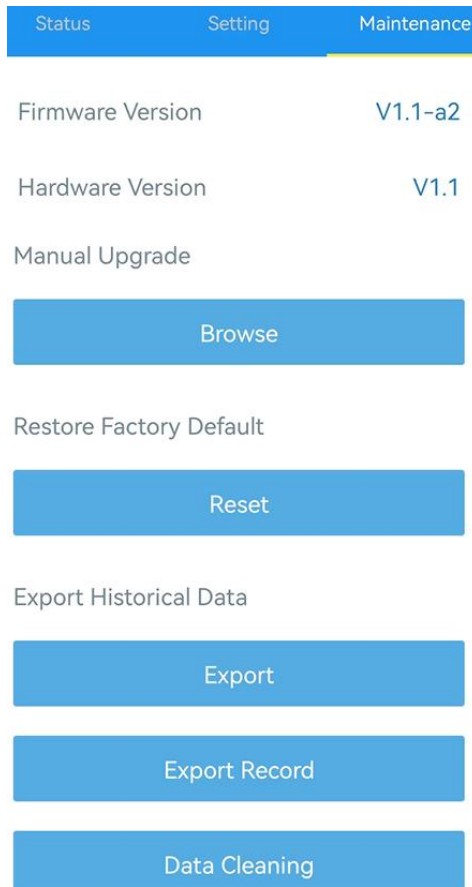

3.4.4 Data Retransmission

EM320-TH supports data retransmission to ensure network server can get all data even if network is down for some times. There are two ways to get the lost data:

- Network server sends downlink commands to enquire the historical data for specifying time range, see section [5.4](#);
- When network is down if no response from LinkCheckReq MAC packets for a period of time, the device will record the network disconnected time and re-transmit the lost data after device re-connects the network.

Here are the steps for data retransmission:

1. Ensure the device time is correct, please use Toolbox software or ToolBox App to sync the time. If you set LoRaWAN® version as 1.0.3 or later, the network server will use MAC commands to assign the time to device every time when the sensor joins to network.
2. Enable data storage feature and data retransmission feature;

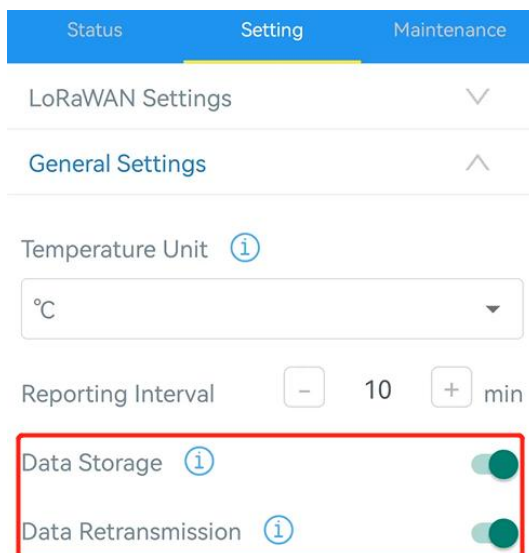

3. Go to "**Device -> Settings -> General Settings**" of ToolBox App to enable rejoin mode feature and set the number of packets sent. Take below as example, the device will send LinkCheckReq MAC packets to the network server at least every 30 mins to check if the network is disconnected; if there is no response for 8 times ($8 * 30 \text{ mins} = 240 \text{ mins} = 4 \text{ hours}$), the device will record a data lost time point(disconnection time minus 4 hours).

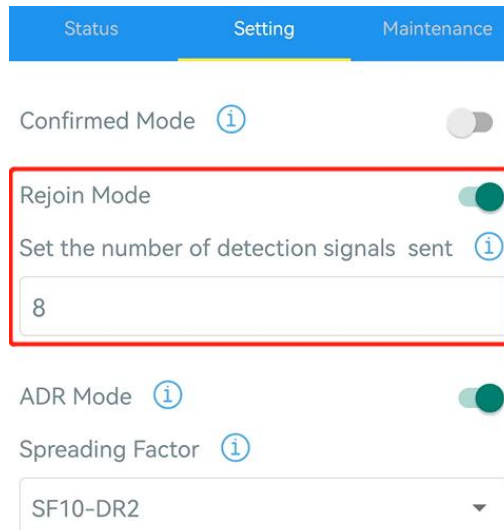

Setting

Confirmed Mode i

Rejoin Mode

Set the number of detection signals sent i

8

ADR Mode i

Spreading Factor i

SF10-DR2

4. After the network connected back, the device will send the lost data from the point in time when the data was lost according to the reporting interval.

Note:

- 1) If the device is rebooted or re-powered when data retransmission is not completed, the device will re-send all retransmission data again after device is reconnected to the network;
- 2) If the network is disconnected again during data retransmission, it will only send the latest disconnection data;
- 3) The retransmission data format is started with "20ce", please refer to see section [5.4](#).
- 4) Data retransmission will increase the uplinks and shorten the battery life.

3.5 Maintenance

3.5.1 Upgrade

ToolBox App:

1. Download firmware from www.milesight-iot.com to your smartphone.
2. Open ToolBox App and click "Browse" to import firmware and upgrade the device.

Note:

- 1) Operation on ToolBox is not supported during the upgrade.
- 2) Only Android version ToolBox supports the upgrade feature.

SN	6785C38226020003
Model	EM320-TH-915M
Firmware Version	V1.1-a2
Hardware Version	V1.1
Manual Upgrade	

Browse

3.5.2 Backup

EM320-TH sensor supports configuration backup for easy and quick device configuration in bulk. Backup is allowed only for devices with the same model and LoRaWAN® frequency band.

ToolBox App:

1. Go to “Template” page on the App and save current settings as a template. You can also edit the template file.
2. Select one template file that saved in the smartphone and click “Write”, then attach it to another device to write configuration.

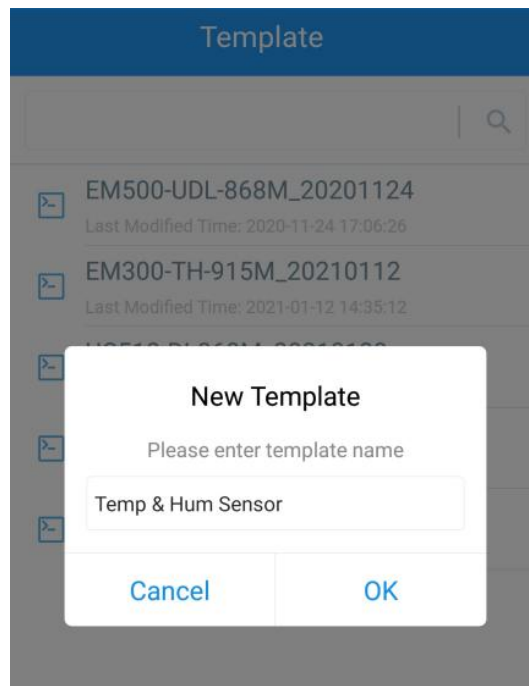

Note: Slide the template item to the left to edit or delete it. Click the template to edit the configurations.

Template	
<input type="text"/>	<input type="text"/>
<input type="checkbox"/> EM500-UDL-868M_20201124 Last Modified Time: 2020-11-24 17:06:26	
<input type="checkbox"/> EM300-TH-915M_20210112 Last Modified Time: 2021-01-12 14:35:12	
<input type="checkbox"/> UC512-DI-868M_20210128 Last Modified Time: 2021-01-28 16:57:20	
<input type="checkbox"/> UC501-470M_20210201 Last Modified Time: 2021-02-01 11:29:43	
<input type="checkbox"/> M_20210208 Last Modified Time: 2021-02-08 16:44:37	<input type="button" value="Edit"/> <input type="button" value="Delete"/>

3.5.3 Reset to Factory Default

Please select one of following methods to reset device:

Via Hardware: Hold on reset button inside the device more than 10s.

Via ToolBox App: Go to **"Device -> Reset"** to click "Reset", then attach smart phone with NFC area to device to complete reset.

Status	Setting	Maintenance
SN	6785C38226020003	
Model	EM320-TH-915M	
Firmware Version	V1.1-a2	
Hardware Version	V1.1	
Manual Upgrade		
<input type="button" value="Browse"/>		
Restore Factory Default		
<input type="button" value="Reset"/>		

4. Installation

Standard Version:

1. Remove the backplate on the back of the device, screw the wall plugs into the wall and fix the backplate with screws on it, then install back the device. Note that the vent of device should not face upwards when installing.

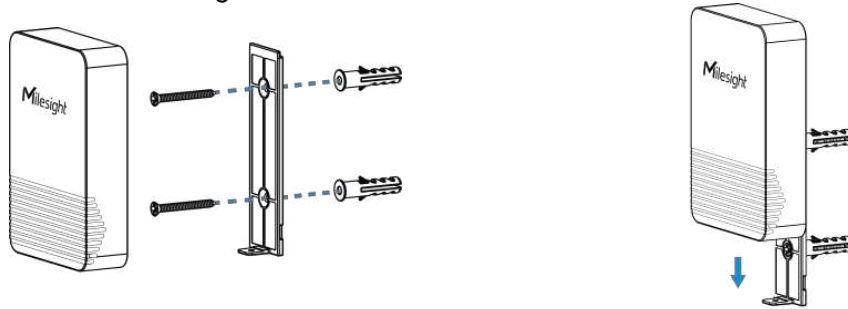

2. Fix the bottom of the device to the cover with a fixing screw.



Magnetic Version:

Attached the device to a magnetic surface such as the metal surface of the refrigerator, freezer, freight container, etc. The back of the device is equipped with anti-slip pad to secure firm and sturdy installation. Note that the vent should not face upwards.

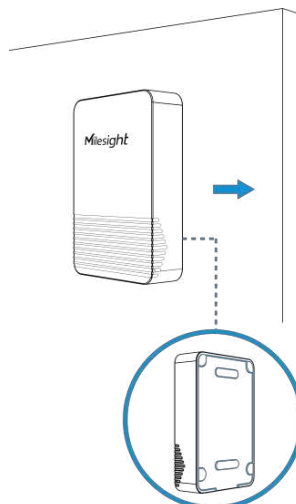

5. Device Payload

All data are based on following format (HEX), the Data field should follow little-endian:

Channel1	Type1	Data1	Channel2	Type2	Data2	Channel 3	...
1 Byte	1 Byte	N Bytes	1 Byte	1 Byte	M Bytes	1 Byte	...

For decoder examples please find files on <https://github.com/Milesight-IoT/SensorDecoders>.

5.1 Basic Information

EM320-TH sensors report basic information of sensor whenever joining the network.

Channel	Type	Description
ff	01 (Protocol Version)	01=>V1
	09 (Hardware Version)	01 40 => V1.4
	0a (Software Version)	01 14 => V1.14
	0b (Power On)	Device is on
	0f (Device Type)	00: Class A, 01: Class B, 02: Class C
	16 (Device SN)	16 digits

Example:

ff166785c38226020003 ff090110ff0a0101ff0f00					
Channel	Type	Value	Channel	Type	Value
ff	16 (Device SN)	6785c38226020003	ff	09 (Hardware version)	0110 (V1.1)
ff	0a (Software version)	0101 (V1.1)	ff	0f (Device Type)	00 (Class A)

5.2 Sensor Data

EM320-TH sensors report sensor data according to reporting interval (10mins by default).

Item	Channel	Type	Description
Battery Level	01	75	UINT8, Unit: %
Temperature	03	67	INT16, Unit: °C, Resolution: 0.1 °C
Humidity	04	68	UINT8, Unit: %RH, Resolution: 0.5 %RH

Example:

017564 03672201 046850					
Channel	Type	Value	Channel	Type	Value
01	75 (Battery Level)	64=>100%	03	67 (Temperature)	22 01=>01 22=>290 Temp=290*0.1 =29°C
Channel	Type	Value	Channel	Type	Value
04	68 (Humidity)	50=>80 Hum=100* 0.5 =69%			

5.3 Downlink Commands

EM320-TH sensors support downlink commands to configure the device. The application port is 85 by default.

Channel	Type	Description
ff	02(Set Collecting Interval)	2 Bytes, unit: s
	03(Set Reporting Interval)	2 Bytes, unit: s
	06 (Set Threshold Alarm)	9 Bytes, CTRL(1B)+Min(2B)+Max(2B)+ 00000000(4B) CTRL: Bit0~Bit2: 000-disable 001-below (minimum threshold) 010-over (maximum threshold) 011-within 100-below or above Bit3~Bit7: 11001
	10 (Reboot)	ff (Reserved)

Example:

1. Set reporting interval as 20 minutes.

ff03b004		
Channel	Type	Value

ff	03 (Set Reporting Interval)	b0 04=>04 b0=1200s =20 minutes
----	-----------------------------	--------------------------------

2. When temperature is below 20°C or over 30°C, it will upload current value immediately.

ff06ccc8002c0100000000		
Channel	Type	Value
ff	06 (Set Threshold Alarm)	Ctrl: cc=>11001 100 100=> below or over Min: c8 00=>00 c8= 20 °C Max: 2c01 => 01 2c= 30 °C

3. Reboot the device.

ff10ff		
Channel	Type	Value
ff	10 (Reboot)	ff (Reserved)

5.4 Historical Data Enquiry

EM320-TH sensors support sending downlink commands to enquire historical data for specified time point or time range. Before that, ensure **the device time is correct and data storage feature was enabled to store the data.**

Command format:

Channel	Type	Description
fd	6b (Enquire data in time point)	4 Bytes, unix timestamp
fd	6c (Enquire data in time range)	Start time (4 bytes) + End time (4 bytes), Unix timestamp
fd	6d (Stop query data report)	ff
ff	6a (Report Interval)	2 Bytes, unit: s, range: 30~1200s (60s by default)

Reply format:

Channel	Type	Description
fc	6b/6c	00: data enquiry success 01: time point or time range invalid 02: no data in this time or time range

20	ce (Historical Data)	Data time stamp (4 Bytes) + Data Contents (Mutable)
----	----------------------	---

Note:

1. The device only uploads no more than 300 data records per range enquiry.
2. When enquiring the data in time point, it will upload the data which is closest to the search point within the reporting interval range. For example, if the device reporting interval is 10 minutes and users send command to search for 17:00's data, if the device find there is data stored in 17:00, it will upload this data; if not, it will search for data between 16:50 to 17:10 and upload the data which is closest to 17:00.

Example:

1. Enquire historical data between 2022/10/12 15:15:00 to 2022/10/12 16:35:00.

fd6c 74694663 347c4663		
Channel	Type	Value
fd	6c (Enquire data in time range)	Start time: 74694663 => 63466974 = 1665558900 =2022/10/12 15:15:00 End time: 347c4663 => 63467c34 = 1665563700 =2022/10/12 16:35:00

Reply:

fc6c00		
Channel	Type	Value
fc	6c (Enquire data in time range)	00: data enquiry success

20ce 9e744663 1001 5d			
Channel	Type	Time Stamp	Value
20	ce (Historical Data)	56991a63 => 2022/10/12 16:03:53	Temperature: 1001=>0110=27.2°C Humidity: 5d=>93=56.5%