

WebRelay Wireless

USERS MANUAL Revision 1.0



For models: XW-210-I

Wi-Fi Relay Control, Input Status Alerting, & Temperature Monitoring • No Wiring Needed

Features

- ▶ Wireless Wi-Fi 802.11 b/g/n
- ▶ Transmission range up to 250ft.
- ▶ Built-in web server and WPS for setup, configuration and remote monitoring.
- ▶ Internal high-current relay. Use the relay to control lights, motors, and other equipment.
- ▶ Optically-isolated digital input. Use the input to control relays, trigger email messages, or control relays on other ControlByWeb devices.
- ▶ Up to 4 digital temperature sensors or other Xytronix 1-Wire sensors.
- ▶ Configurable logging of the input, temperature, humidity, and relay states.



DIREKTRONIK

Direktronik AB tel. 08-52 400 700 www.direktronik.se

XW-210 User Manual Revisions	
Revision	Description
1.0	Initial release.

Table of Contents

Section 1: Introduction.....	6
1.1 Features.....	7
1.2 Part Numbers and Accessories.....	8
1.3 Wireless Communication Notes.....	9
1.4 Security Notes.....	9
1.5 Connectors & Indicators.....	10
1.6 Accessing the WebRelay Wireless using a Web Browser.....	12
Section 2: Installation and Connections.....	13
2.1 Installation Guidelines.....	13
2.1.1 Wall Mounting.....	13
2.1.2 DIN-Rail Mounting.....	13
2.2 Making Connections.....	14
2.2.1 Power Supply Connections.....	14
2.2.2 Antenna Connection.....	15
2.3 Relay Connections (Control a device over an IP network).....	16
2.4 1-Wire Sensor Connections.....	17
2.5 Digital Input Connections.....	19
2.5.1 DC Input.....	19
2.5.2 Switch Closure Connections.....	20
2.5.3 Water Leak Sensor Connections.....	21
2.5.4 AC Input Connections.....	22
Section 3: Provisioning.....	23
3.1 Method 1: Access Point.....	23
3.2 Method 2: WPS (Wi-Fi Protected Setup).....	23
3.3 Application Examples.....	25
3.3.1 Warehouse Temperature Example with no Access Point.....	25
3.3.2 Warehouse Temperature Example with an Access Point.....	25
Section 4: Web Server.....	26
4.1 Main Tab.....	26
4.2 WiFi Networks Tab.....	28
4.3 Password Tab.....	35
4.4 Date/Time Tab.....	36
4.5 Logging Tab.....	39
4.6 Input Tab.....	41
4.7 Relay Tab.....	43
4.8 Sensor Tab.....	48
4.9 Script Tab.....	51
4.9.1 Example Script.....	52
4.10 Control Page and Register Setup Tab.....	53
Section 5: Control Page.....	55
5.1 Browser Operation.....	55
5.2 Control Page Tab.....	57

Section 6: Auxiliary Operations	58
6.1 XML	58
6.1.1 state.xml.....	58
6.1.2 XML Control.....	59
6.1.3 Message Acknowledgment.....	60
6.2 HTTP GET Requests (for custom applications)	61
6.2.1 Using GET for Control and Monitoring.....	61
6.3 External Server and Remote Services	62
6.3.1 Accessing the WebRelay Wireless with custom software or third party applications.....	62
6.3.2 Using an External Web Server.....	62
6.3.3 Direct Server Control.....	62
6.3.4 Remote Services.....	62
6.3.5 Connection String.....	63
6.4 Email Notification	64
6.4.1 Email Notification Description.....	64
6.4.2 Email Notification Setup.....	65
6.5 LogFile	66
6.5.1 Data Log File – log.txt.....	66
6.6 Modbus/TCP	68
6.6.1 WebRelay Wireless Modbus Function Code Summary.....	68
6.6.2 PLC Device Addressing.....	69
6.6.3 WebRelay Wireless Full Address Table.....	70
6.6.4 Read Coils - Modbus Function Code 01 (0x01).....	71
6.6.5 Read Discrete Inputs – Modbus Function Code 02 (0x02).....	72
6.6.6 Read Sensors – Modbus Function Code 03 (0x03).....	73
6.6.7 Write Single Coil – Modbus Function Code 05 (0x05).....	74
6.6.8 Write Multiple Coils - Modbus Function Code 15 (0x0F).....	75
6.6.9 Write Multiple Registers – Modbus Function Code 16 (0x10).....	76
6.7 Basic Scripts	77
6.7.1 Structure.....	77
6.7.2 Line Format.....	77
6.7.3 Supported Statements.....	78
6.7.4 User-Defined Variables.....	80
6.7.5 Predefined Variables.....	80
6.7.5.1 Timer Variables.....	80
6.7.5.2 Relay Variables.....	80
6.7.5.3 Input Variables.....	81
6.7.5.4 Counter Variables.....	81
6.7.5.5 Vin Variable.....	81
6.7.5.6 Temperature/Other Sensor Variables.....	81
6.7.5.7 Date and Time Variables.....	81
6.7.5.8 Event Variables.....	82
6.7.6 Registers.....	82
6.7.7 Testing and Debugging.....	83
Appendix A: Specifications	84
Appendix B: Trademark and Copyright Information	87
Appendix C: Warranty	88
Appendix D: FCC Statement	89
Appendix E: Mechanical Dimensions	90

Section 1: Introduction

The WebRelay Wireless™ module is an easy to use Wi-Fi enabled relay, temperature monitor and status alerting device. The WebRelay Wireless has a built-in relay for controlling lights, motors and other relatively high current loads, a digital input which can be used to monitor and report the status of switch-closure sensors and a “1-Wire” port for connecting up to four digital temperature or other Xytronix 1-Wire sensors. It is ideal for applications where devices must be controlled or where temperature or events must be monitored and Ethernet wiring is not accessible or practical to install. The module is powered by an external wall transformer (9-28 VDC), solar panel, or other DC power source.

The WebRelay Wireless works well as a standalone device that can be controlled using a web browser. It can be configured using simple menus and drop-down lists. It includes features such as logging, input state monitoring, and the ability to control other relays on other devices.

The WebRelay Wireless can be a self-contained wireless access point that requires no additional servers or ControlByWeb devices. In this mode it provides live, real-time temperatures or an input's status directly to a user through web browsers or through the CBW Mobile app.

After being commissioned, the WebRelay Wireless can recognize and attach to your Wi-Fi access point (i.e., router). The WebRelay Wireless offers the ability to control its relay, and monitor temperature sensors and input status. It can send out email alerts (which can be converted to text message alerts) whenever an alarm condition occurs.

Plug-in terminal strips provide connections for the DC power, relay contacts, optically-isolated input and up to 4-temperature or other Xytronix 1-Wire sensors. No other cables, interfaces, or PC utility programs are needed.

Two push-button switches aid in provisioning the module. Press the “Access Point” button anytime to active the access point mode. With a Wi-Fi enabled PC or smart phone, you then connect to and access the internal web server at its default IP address, port and password. Using the web server, you configure the access port, name and other setup parameters. Alternatively, add the WebRelay Wireless module to an existing network by pressing the “WPS” (Wi-Fi Protected Setup) button on both your access point (i.e., router) and the module.

The WebRelay Wireless supports a number of Ethernet protocols with its built-in server, including HTTP, Modbus/TCP, NTP, and XML.



It also has a built-in BASIC interpreter. A control script can be written for custom applications not provided by the normal control functions.



1.1 Features

- Wireless Wi-Fi 802.11 b/g/n.
- Transmission range up to 250ft.
- Built-in web server for configuration and remote monitoring.
- Built-in high current relay.
- Optically-isolated digital input. Use the input to control relays or trigger email/text messages.
- Pulse counter.
- “1-Wire” port for connecting up to 4 digital temperature or other Xytronix 1-Wire sensors.
- Temperature sensors are accurate to +/-0.5°C from -10°C to +85°C.
- Temperature probes are interchangeable and need no calibration.
- Powered from a 9 to 24V DC power adapter. The power supply voltage is monitored internally and can be logged.
- Sensor/Input status can control a relay on the module and/or another ControlByWeb device.
- Configurable logging of the input, counter, temperature, humidity, relay state and Vin.
- Real-time clock with manual or NTP time sync.
- Send email alerts (up to 8 addresses) based on any relay, sensor, or input conditions.
- Auxiliary protocols including XML, Modbus/TCP and Remote Services.
- Custom scripts using the built-in BASIC interpreter provide additional flexibility.
- Simple and easy to use.
- UL Listed
- 5-year warranty.

1.2 Part Numbers and Accessories

Device	Description	Part Number
WebRelay Wireless	Wireless WebRelay with built-in web server	XW-210-I
Temperature Sensor	Digital temperature sensor with short wire leads (connects directly to the terminal strip)	X-DTS-U
Temperature Sensor	Digital temperature sensor with 3 foot wire leads (housed in water resistant stainless steel probe)	X-DTS-S3C
Temperature Sensor	Digital temperature sensor with 32 foot wire leads (housed in water resistant stainless steel probe)	X-DTS-S32C
Magnetic Temperature Sensor Mount 	Magnetic mount for the temperature sensor probe	XW-SMK-1
Temperature/Humidity Sensor Probe 	Digital temperature and humidity sensor probe -40°C to +80°C ±0.4°C, 0-99%RH ±2%	X-DTHS-P
Thermocouple to 1-Wire Adapter 	Thermocouple to 1-Wire interface, Type K -200°C to +1250°C, ±.5°C	X-TC1W-K
Power Supply	Wall Transformer, 100-240VAC in, 12V, 1.5A out	PS12VW1.5-B
Water Leak Sensor	Water leak sensor	GRI-2605
Spare Connector	8-position, screw terminal connector	X-TERM8A
Spare Connector	3-position, screw terminal connector	X-TERM3B

1.3 Wireless Communication Notes

Due to the nature of wireless communications, transmission and reception of data can not be guaranteed. Data may be delayed, have errors, or be lost. Although delays or losses of data are rare with a well constructed network, data can be lost due to interference, noise, reflections, or other environmental conditions. The WebRelay Wireless module should not be used in situations where failure to transmit or receive data could result in damage to property, equipment, direct, indirect, consequential, or incidental damage, including damage for loss of business profit, business interruption, loss of data, life, and the like.

1.4 Security Notes

WebRelay Wireless is a dedicated device and does not employ a general purpose computer operating system (i.e. Windows, Linux etc.) It does not have features such as telnet, FTP, SSH, nor uncontrolled open ports. This means it is extremely difficult, if not impossible, for someone to 'break in' to the WebRelay and access other devices on your local network. The simplicity of the WebRelay makes it an inherently secure device. Nevertheless, as with any device installed on a network, appropriate security precautions should be observed.

It is recommended that passwords be enabled for the *Control Page and Setup Pages*. Passwords should be at least 8 characters in length and use a combination of upper and lower case letters and numbers. For additional security, a firewall may be used to limit access to selected IP addresses.

The firmware in the WebRelay can be upgraded, but not over the internet. By design, a firmware upgrade requires physical access to the buttons on the faceplate.

1.5 Connectors & Indicators

Relay

The WebRelay Wireless module has an internal, high-current relay. Screw terminals are provided for the *Common*, *Normally Open*, and *Normally Closed* contacts of the relay. The screw terminals are internally connected directly to the relay with no internal fuse or other over-current protection. The relay contacts are isolated from all other circuits. Trigger email/text messages based upon relay states.

Digital Input

The WebRelay Wireless module has an optically-isolated digital input. The optically-isolated input provides electrical isolation between the digital input and the low voltage control circuits of the module. The input can be used as a pulse counter and has a built-in debounce of 20ms. Trigger email/text messages based upon input states.

1-Wire Sensor Bus

The WebRelay Wireless works with “1-Wire” digital temperature sensor and other Xytronix 1-Wire sensors. The sensors are available in several configurations, are interchangeable and require no calibration. The sensors require three connections for communications and power: +5V, Gnd, and Data. Control relays or trigger email/text messages based upon temperature and other sensor values.

Power Supply

The WebRelay Wireless employs modern switch-mode power supply which works from 9 to 28VDC. With this type of power supply the current draw decreases as the voltage increases. The power supply voltage (+Vin) is monitored internally and can be logged.





LED Indicators

Power: Illuminated whenever the module is powered

Relay: Illuminated whenever the relay is energized

Input: Illuminated when a sufficient voltage is applied to the digital input

Link: See table below:

Wi-Fi State	LINK LED
<i>Not connected</i>	Off
<i>WPS in progress</i>	Slow flashing (1 time every 4 seconds) 
<i>Access Point mode</i>	Med flashing (2 times per second) 
<i>Connected to network waiting for DHCP</i>	Fast flashing 
<i>Connected to network with static or DHCP</i>	Solid on 

The WebRelay Wireless has an 8-position removable screw terminal connector for power, input and sensor connections. A separate 3-pin connector provides connections to the internal relay.

8-Pin Connector	
Terminal	Description
Vout	+5V output to power 1-Wire sensor(s), 50mA max
Data	Serial data line for 1-Wire sensor(s)
Gnd	Gnd output for 1-Wire sensor(s)
Din+	Digital Input + The positive side of the optically-isolated input.
Din-	Digital Input - The negative side of the optically-isolated input.
Gnd	- Power Input (GND)
Gnd	- Power input (GND)
+Vin	+9 to 28VDC power input

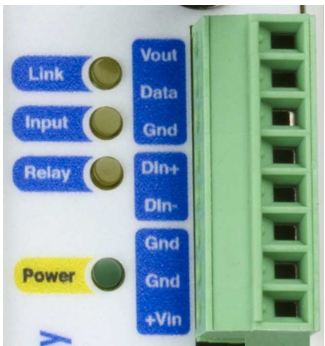

3-Pin Connector	
Terminal	Description
C	Relay COMMON
NO	Relay NORMALLY OPEN
NC	Relay NORMALLY CLOSED



1.6 Accessing the WebRelay Wireless using a Web Browser

The WebRelay Wireless has a built-in web server that provides simple web pages that can be accessed directly using a standard web browser. This allows users to access the unit with NO SPECIAL SOFTWARE installed on their computer. This is ideal for applications that require a quick, simple solution that does not need to be accessible to more than a few people. This configuration is simple to setup, simple to use, and can be accessed from just about any computer or smart phone with Internet access.

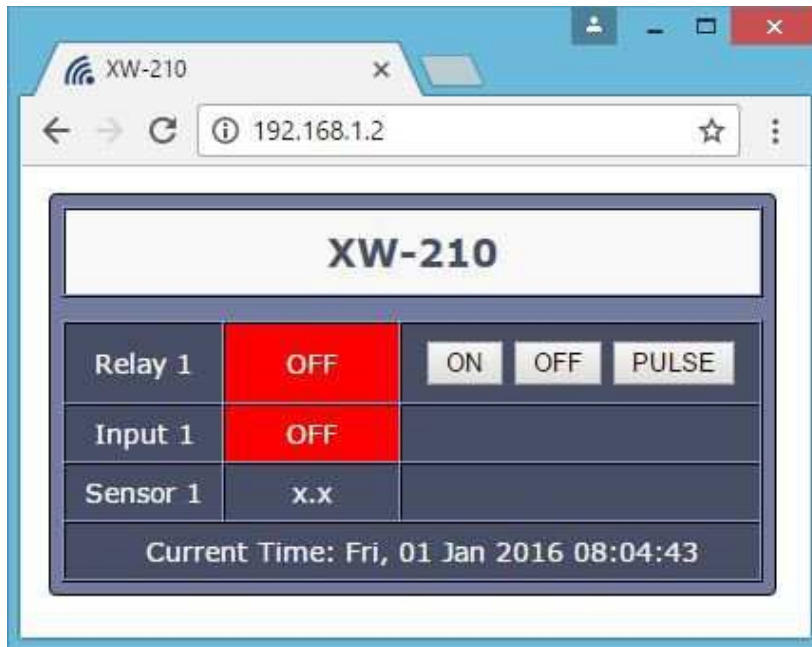

Section 2: Installation and Connections

Installation consists of mounting the WebRelay Wireless and connecting it to a power source. See Provisioning for instructions on commissioning the WebRelay such that it can recognize and connect to your Wi-Fi access point (i.e. router).

2.1 Installation Guidelines

- This unit must be installed by qualified personnel.
- This unit must not be installed in unprotected outdoor locations.
- The WebRelay Wireless module must be installed inside an NRTL certified industrial control panel or similar NRTL certified fire/electrical enclosure.
- If this unit is used in a manner not specified by Xytronix, the protection provided by the equipment may be impaired.
- This unit must not be used for medical, life saving purposes, or for any purpose where its failure could cause serious injury or the loss of life.
- This unit must not be used in any way where its function or failure could cause significant loss or property damage.
- Do not use to directly control motors or other actuators not equipped with limit switches or other safeguards to protect from equipment or wiring failures.
- The WebRelay Wireless module should be located in a clean, dry location where it is protected from the elements. Ventilation is recommended for installations where ambient air temperatures are expected to be high. See Appendix E: Mechanical Dimensions for additional mechanical details.

2.1.1 Wall Mounting

Mount the WebRelay Wireless module to a wall by using two #8 screws. Attach the screws to the wall vertically spaced exactly 2.5 inches apart. The head of the screw should be about 1/10 inch away from the wall.

2.1.2 DIN-Rail Mounting

The WebRelay Wireless module can be mounted to a standard (35mm by 7.55mm) DIN-Rail. Attach the module to the DIN-Rail by hooking the top hook on the back of the enclosure to the DIN-Rail and then snap the bottom hook into place. To remove the module from the DIN-Rail, use a flat-head screwdriver. Insert the screwdriver into the notch in the release tab and pry against the enclosure to release the bottom hook.

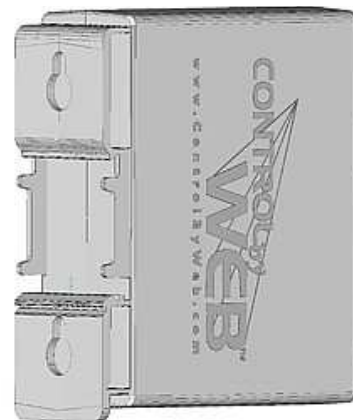

2.2 Making Connections

CAUTION: Make sure the power is shut off before making connections

CAUTION: This unit should be installed by a qualified technician.

CAUTION: Miswiring or misconfiguration could cause permanent damage to the WebRelay, the equipment to which it is connected, or both.

A removable terminal connector is provided for making the power connections. To help protect the WebRelay Wireless module from mechanical stress remove the terminal connector before making the connections.

1. Make sure power is turned off.
2. Remove the terminal connector from the module and make wiring connections to the terminals. This technique avoids stressing the internal components while torquing the screws.
3. Reconnect the terminal connector.
4. Apply power.

It is recommended that any load (device to be controlled) not be connected until after the WebRelay Wireless module has been configured and tested. By doing this, wiring and configuration mistakes will not cause the load to turn on unexpectedly. Make certain the wires are properly inserted into the terminals and that the screws are tight.

See Appendix A: Specifications for wire size, temperature rating and torque requirements for making connections to the terminal blocks.

2.2.1 Power Supply Connections

The WebRelay Wireless module requires power for its internal logic circuits. Connect a 9-28 VDC power supply to the +Vin and GND terminals. A regulated power supply is recommended, such as a wall-mount AC-DC adapter. Verify that the adapter is rated for the operating current of the module (See Appendix A: Specifications for the current requirements.) Multiple WebRelay Wireless modules may be connected to a single power supply by connecting the power supply input terminals in parallel. The power supply must have a high enough current rating to power all units connected. If the WebRelay is powered with a solar panel, the system must include a solar charge controller and a battery.

2.2.2 Antenna Connection

The WebRelay Wireless module comes with an approved 2.4GHz omnidirectional antenna for use with WLAN devices using WiFi (802.11b/g/n). The omnidirectional pattern is suitable for point-to-multipoint broadcasting in all directions. Connect the antenna to the Reverse SMA connector on the faceplate. Do not operate the WebRelay Wireless module without the antenna connected.

The omnidirectional antenna radiates RF signals in all directions in one plane with a pattern shaped somewhat like a doughnut or torus. The radiated power decreases above or below the plane, dropping to zero on the antenna's axis. Orient the antenna vertically so the antenna will radiate in all horizontal directions and so little radio energy is aimed into the sky or down toward the earth and lost.

This module has been approved to operate with an antenna (provided) with the maximum permissible gain specified in the specification (*Appendix A: Specifications*). Antenna types not included in this specification, having a gain greater than the maximum gain indicated for that type, are strictly prohibited for use with this device.

The antenna used for this transmitter must be installed to provide a separation distance of at least 20 cm from all persons and must not be co-located or operating in conjunction with any other antenna or transmitter except in accordance with FCC multi-transmitter product guidelines.

2.3 Relay Connections (Control a device over an IP network)

The illustration below shows a simple example of using the relay in the WebRelay Wireless module to control a device over an IP network. The device to be controlled is wired in series with the relay contacts.

Note: The circuit must include a fuse or circuit breaker to provide over-current protection.

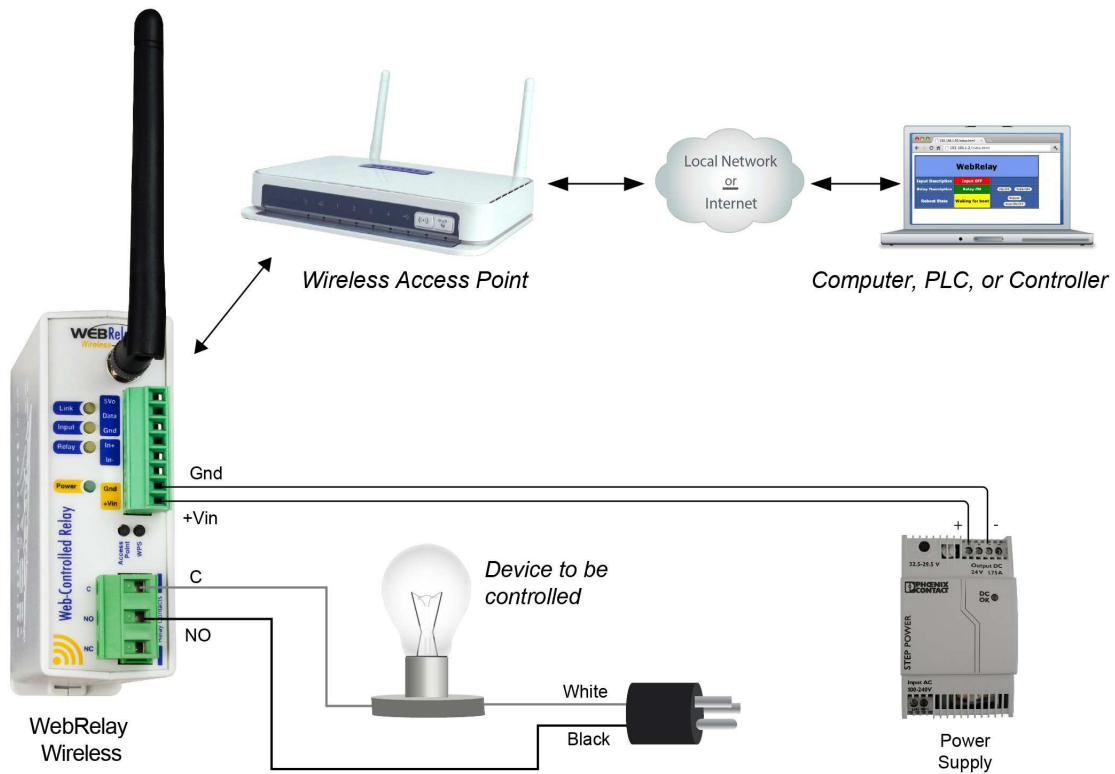

2.4 1-Wire Sensor Connections

The WebRelay Wireless has a “1-Wire” port which supports up to four digital temperature or other Xytronix 1-Wire sensors. The sensors share the same three connections for communications and power (+5V, Ground, Data). Every sensor on the bus is assigned a unique serial number when it is manufactured. That number is used to address the sensor during communication.

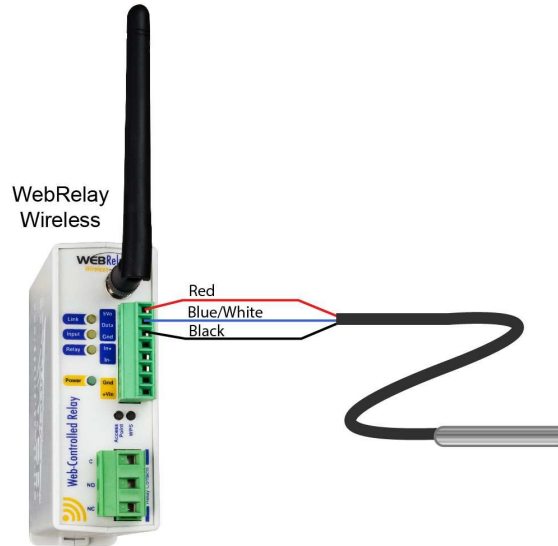

The temperature sensors are interchangeable and require no calibration. The sensors accuracy is +/- 0.5°C (-10°C to +85°C). The temperature sensor is available in several configurations. The encapsulated version has a stainless steel probe and can be used in outdoor applications; however, the probe is not suitable for immersion or use in pressure vessels. For immersion and other demanding applications use a thermowell to protect the sensor. The basic sensor (non-encapsulated) must be used in protected locations. The temperature sensors have three wires as shown below.

Sensor Wire Color	Connection
Red	+5V
Black	Gnd
Blue, White, Yellow	Data

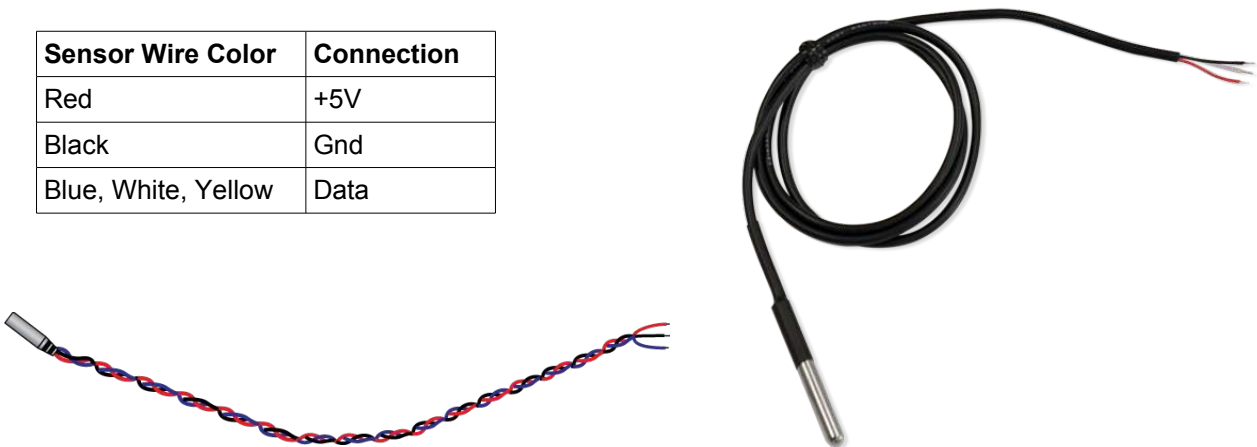

Multiple sensors can be connected in two ways: directly connected (star topology) or “daisy chained” (linear topology). Many factors can determine the maximum length of the cable, including the sensor network topology, the type of cable used, the number of sensors and ambient electromagnetic noise.

Combined cable lengths to all sensors of 600 ft using Cat 5e cable have been successful; however, due to the uniqueness of installation environments, results may vary. Please test in the desired environment before making a permanent installation.

The following are general recommendations that will maximize sensor runs and minimize problems. Cat 5 and Cat 5e network cable has proven to be an effective and low-cost solution for long runs. Other cable types can be used, but cable capacitance generally limits the length. The illustration shows the recommended connection using Cat 5 network cable. Connect all unused conductors to ground.

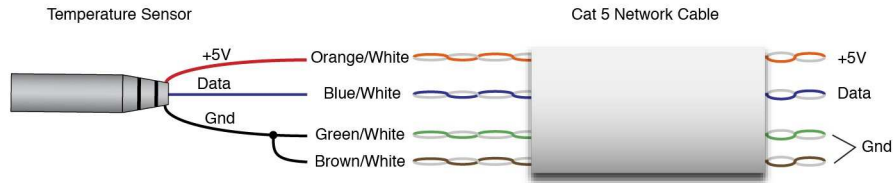

Recommended connections using Cat5 cable

A linear (daisy chain) topology will minimize signal reflections, providing a more reliable connection and will allow longer cable length than a star topology.

The 1-Wire bus is "single-ended" and has no intrinsic noise protection. It is susceptible to interference if the cable is routed near power lines, fluorescent fixtures, motors or other noise sources. Keep the cable wiring short and avoid routing it near other electrical equipment.

2.5 Digital Input Connections

The WebRelay Wireless has an optically-isolated digital input which can be used to control the relay and/or a remote relay (over the network), or simply to monitor the state of a device. To use this input, connect a DC control voltage directly to the input, and customize the input function using the configuration pages.

2.5.1 DC Input

The digital input is connected internally through a current-limiting resistor directly to a photo-coupler circuit. No external resistor is necessary as long as the input signal is within the proper range (See *Appendix A: Specifications*). A DC voltage can be reduced with an external resistor of the appropriate value and power rating to reduce the input current.

The digital input has an internal 3K ohm resistor. The forward voltage drop of the photo-coupler is approximately 1.2V and works well with an input current of 9mA. Use the following formula to determine the resistor value needed for other voltage ranges:

$$R = ((V_{in} - 1.2) / 0.009) - 3000$$

Where:

- R = External resistor value required
- V_{in} = Desired input voltage
- 1.2V = forward voltage drop of the LED in the photo coupler
- .009A = workable LED current
- 3000 ohm = Internal resistor

For example:

To connect a 48VDC signal voltage to the WebRelay Wireless:

$$R = ((48 - 1.2) / 0.009) - 3000 = 2200 \text{ ohms}$$

Check the power dissipated by the resistor:

$$P = I \times I \times R, \text{ The resistor must be at least } .009 \times .009 \times 2200 = 0.18 \text{ Watts, so use a } 1/2 \text{ Watt resistor.}$$

2.5.2 Switch Closure Connections

The WebRelay Wireless module can sense the state of a switch-closure sensor. Sensors with switch-closure outputs include push buttons, magnetic door alarm switches, micro-switches, or any device which has a relay, switch closure or open collector output. The module can be configured for the alarm to be active when the switch is either open or closed.

The illustration below shows an example of using the WebRelay Wireless to monitor the status of a gate or door sensor over an IP network. The status of the device is detected with a switch. These types of sensors are called “dry contacts” in that the sensor output is a bare switch with no power source. In this example the voltage source for the switch is provided via the power supply for the WebRelay Wireless module.

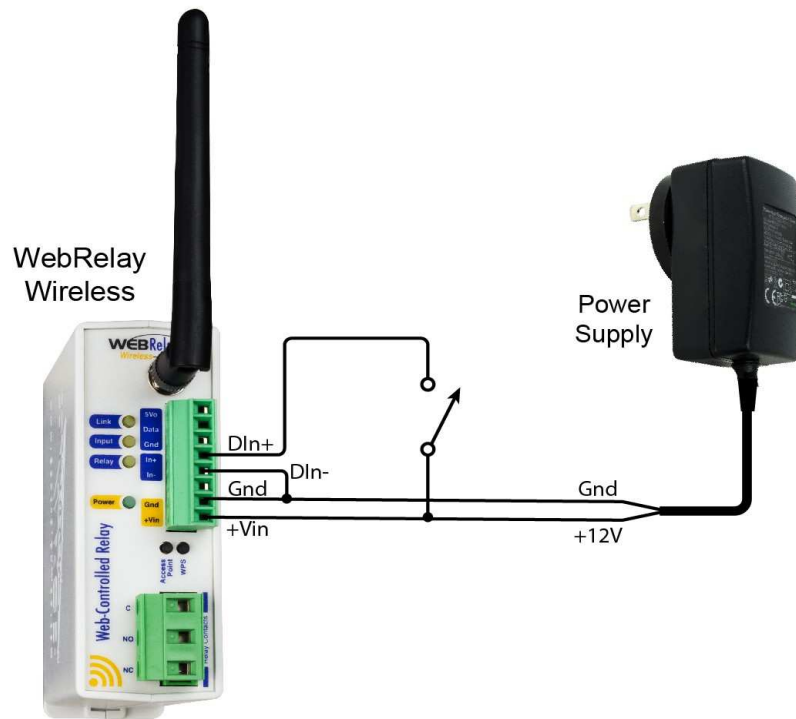

2.5.3 Water Leak Sensor Connections

A GRI-2605 water leak detector can be directly connected to the WebRelay Wireless module. The sensor detects the presence of water or other conductive liquids. The sensor has 4-wires which are connected as shown below. The GRI-2605 has an internal relay whose contacts (green & white wires) are closed when the sensor is dry. When the sensor is dry the digital input will be On.

When water is detected the relay contacts open and the digital input will be Off. With the connections shown the sensor is a closed loop “supervised” alarm circuit such that if a wire is disconnected or the sensor fails, an alarm will be generated. The WebRelay Wireless module can be programmed to activate its relay, activate a relay at a remote location, or send an email/text warning when a water leak is detected. The GRI-2605 is not recommended for submerged applications or prolonged exposure to water. After installation, test the sensor with a damp sponge or wet towel.

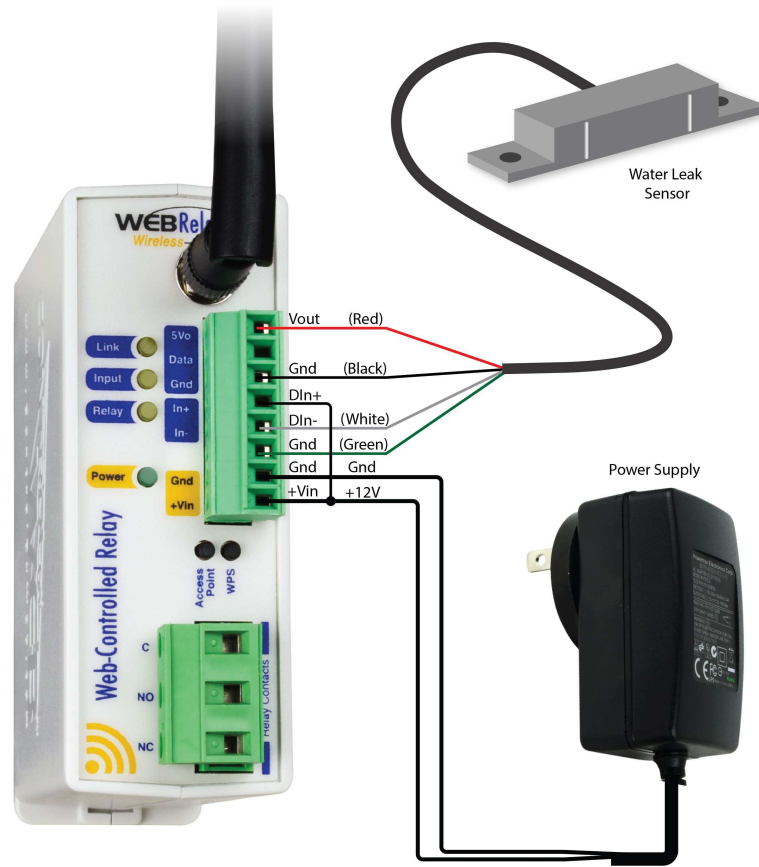

2.5.4 AC Input Connections

If an AC signal voltage needs to be detected, use a signal conditioner to convert the AC signal to a DC voltage within the input range. An AC signal conditioner can be made using a diode (or bridge rectifier) and a capacitor.

Prepackaged signal converters are available as accessories at industrial automation distributors. A simple voltage converter module (RedLion VCM10000 or VCM20000) is shown below. These are available in two input voltage ranges that cover the spectrum from 4-270VAC/DC. These devices have a MOSFET output (solid state DC contact closure) which is compatible with the WebRelay input. The converter module accepts AC (50/60 Hz) or DC voltages with an input pulse rate up to 30 Hz. The converter provides isolation between the input and output using an opto-isolator. You must provide a voltage source for the converter circuit as shown in the example below:

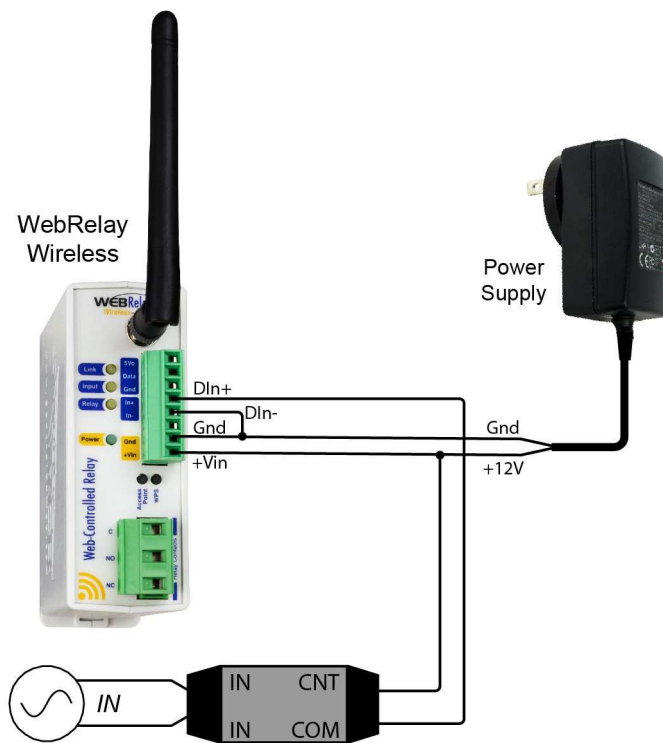

Section 3: Provisioning

After making the sensor connections and providing power, you must provision the WebRelay Wireless module for use on your wireless network. The goal is to configure the module such that it can recognize and attach to your Wi-Fi access point (i.e. router). There are two methods for doing this:

3.1 Method 1: Access Point

By default, the WebRelay Wireless module comes up as a wireless access point when powered for the first time. Pressing the "access point" push button at any time also activates the access point mode. It isn't really an access point because it will not provide internet connectivity to your computer or smart phone, but it will appear as an access point meaning that your computer or smart phone will detect it as an access point and display it as such. When acting as an access point, the WebRelay Wireless module broadcasts an SSID of "XW210-XXXXXX" where XXXXXX are the last six digits of its MAC address.

With your wireless device (laptop computer or smart phone) scan for, and attach to the XW210 wireless network. Next, access the web server in the WebRelay Wireless module using a web browser. To access the setup pages, enter the following URL in the address bar of your web browser:

```
http://192.168.1.2/setup.html
```

After the page is requested, a password prompt will appear. Enter the username and password. The default username is `admin` and the default password is `webrelay` (all lower case). The next chapter explains each of the setup tabs and screens. Use the *WiFi Networks* tab for making the proper settings to allow the WebRelay Wireless module to connect to your access point.

Notes About Access Point Mode:

- As an *Access Point* the WebRelay Wireless module functions independently of other wireless networks. It broadcasts beacons and services Wi-Fi packet requests. In this mode, your computer or smart-phone is connected directly with the module on a private network and is NOT using another Wi-Fi network. Typically you would use this for configuration and not for normal operation.
- The WebRelay Wireless module has no hardware "restore defaults" button, to prevent the installer from being locked out, the default username (`admin`) and password (`webrelay`) always work in the access point mode, even if the password is changed. If the password has changed via the *Password* tab, both the new password and the `webrelay` password will work. Additionally, the IP address and HTTP port will temporarily revert to the default values shown above when in the access point mode.
- Only one client (computer or smart-phone) can be connected to the WebRelay Wireless module at a time.
- SSID and password cannot be customized (once again this mode is intended for configuration only).
- Access point is unsecured and open.

3.2 Method 2: WPS (Wi-Fi Protected Setup)

The WPS push-button method, provides a simple method for attaching the WebRelay Wireless module to a wireless network without needing to use any setup pages. Although using this method to connect the module to the network is simple, you will not be able to access the module's web server unless you know the IP address that was assigned by the DHCP sever (router) or unless mDNS services are available on your device. For this reason, it is recommended that you use this method of configuration only when the WebRelay Wireless module units have been pre-configured to operate in a non-web-

server mode or when you have full access to the DHCP server so you can obtain the IP address that was assigned.

To begin, press the WPS button on your wireless router or access-point. You will generally have about two minutes to connect wireless devices to the network with WPS. Now press the "WPS" push button on your WebRelay Wireless module. After a few seconds, the module should register itself with the router or access-point. If WPS fails, the module will automatically enter access point mode.

The WebRelay Wireless module will use DHCP to obtain an IP address after a successful WPS association. Additionally, the connection information is also broadcast using mDNS. If you need to access the module using its internal web server, you will need to obtain the IP address that was assigned to the module through your DHCP server or router. Alternatively, if using an mDNS capable device, it may be accessed by entering the following into the address bar of your web browser:

`http://xw-210.local/setup.html`

3.3 Application Examples

The WebRelay Wireless module can be configured for many different applications. Two general examples are described below:

3.3.1 Warehouse Temperature Example with no Access Point

You wish to monitor the temperature of a warehouse with a your smart phone and you don't have a Wi-Fi access point.

Mount a WebRelay Wireless module inside the warehouse. Power it with a DC wall adapter. If no network profiles have been configured, the module will automatically enter access point mode and you can access the module directly with a computer or smart device with a wireless connection. If the WebRelay Wireless module has been previously configured for other uses, press the Access Point button. Scan for, and attach to the XW210-XXXXXX wireless network. Access the setup pages with the following URL:

```
http://192.168.1.2/setup.html
```

Click the *Restore Defaults* button on the Main setup page. Scan for and reattach to the XW210-XXXXXX network again. The WebRelay Wireless module is workable for this application with the default settings, no further settings are needed. Note, only one device can be connected to the module at a time when it is in the Access Point mode. The WebRelay Wireless module will continue to broadcast an SSID and you can connect to the module anytime with your smart phone and view the temperature on the Control page (<http://192.168.1.2>). Since the WebRelay Wireless module is not connected to the Internet, you must be within 250 feet or so with your smart phone to receive the Wi-Fi signal from the WebRelay Wireless module. The module cannot send emails or remote relay commands because it is not connected to the internet. Be aware that the access point is unsecured and open and the default passwords cannot be changed.

3.3.2 Warehouse Temperature Example with an Access Point

You wish to monitor the temperature of a warehouse with your smart phone or office computer. You have a Wi-Fi access point in the warehouse. The HTTP web server is enabled to provide continuous access to the control page.

Mount the module inside the warehouse. Power it with a DC wall adapter.

First, the WebRelay Wireless module must be configured to access your Wi-Fi network. If no network profiles have been configured, the module will automatically enter access point mode and you can access the module directly with a computer or smart device with a wireless connection. Access the setup pages with the following URL: <http://192.168.1.2/setup.html>

For this application, configure the module to connect to your wireless network. Navigate to the WiFi Networks tab and fill in the appropriate settings for your Wi-Fi network. Obtain the IP address from your network administrator. Press the *Submit* button at the bottom of the page.

Once all of the appropriate settings have been applied, click on the *Reboot* button. The WebRelay Wireless module will connect to, and remain connected to your access point and will now be accessible from the IP address configured on the WiFi Networks tab. The module will no longer broadcast an SSID. You can access the control page any time to monitor the warehouse temperature by entering the IP address that was assigned to the device in the address bar of your web browser. Since your access point is connected to the internet, you can monitor the temperature from any computer in the building. If the module does not connect within a period of time, press the Access Point button and repeat the above steps to verify the network settings.

Section 4: Web Server

The internal web server presents two classes of web pages: *Setup* pages and *Control* pages. *Setup* pages are used by an installer to provision and configure the WebRelay Wireless module. The *Control* page allows the relay to be controlled and displays temperature and digital input status information.

To access the *Control* page, enter the following URL in the address bar of a web browser:

```
http://192.168.1.2
```

To access the *Setup* pages, enter the following URL in the address bar of a web browser:

```
http://192.168.1.2/setup.html
```

Note that if you are accessing the unit as an access point, the above IP address will work even if you have changed the IP address in the Setup pages. If you are accessing the unit through the network after it has been configured you will use the IP address that was assigned to the device.

If the module has been added to a network using WPS, it will use DHCP and you will need to use the IP address assigned to it. This can be found in the DHCP server, or by using mDNS. The mDNS name is:

```
http://xw-210.local/
```

When using the setup pages, you must click the *Submit* button at the bottom of a page if you have made changes to a setting on the page.

4.1 Main Tab

This is the initial page that is displayed when `setup.html` is entered in the address bar of the browser. It displays model and serial number information, and has navigation tabs which allow access to the configuration and setup settings. Each of the configuration settings are described in the following sections.

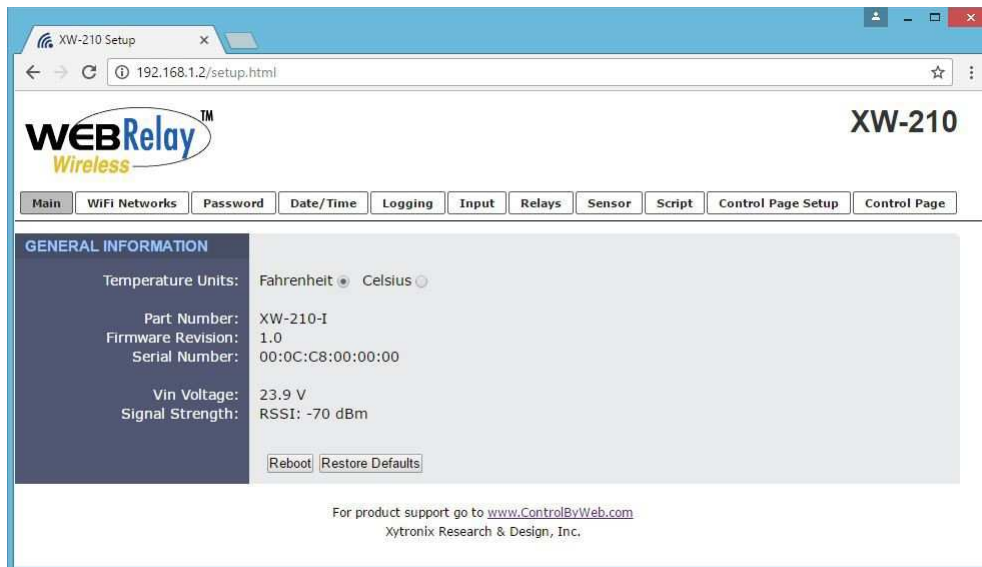

Temperature Units

This global setting selects temperature units of either *Fahrenheit* and *Celsius*. All settings entered and displayed on subsequent pages will be in the units selected.

Part Number

This is the full model number of the WebRelay Wireless (XW-210).

Firmware Revision

This is the current revision of the internal software.

Serial Number

This is the serial number of the module. The serial number is also the MAC address of the unit.

Vin Voltage

This field shows the input voltage on the +Vin and Gnd terminals from your power supply.

Signal Strength

This indicates the current receive Wi-Fi signal strength. The more negative the number, the less signal is being received. -30dBm is a strong signal, and -90dBm is a very weak signal.

Reboot

After showing a confirmation message, this button will send a command to reboot the device.

Restore Defaults

After showing a confirmation message, this button will erase all user settings and return the module to its factory defaults.

4.2 WiFi Networks Tab

As a Wi-Fi client device, the WebRelay Wireless module attempts to automatically connect to configured Wi-Fi access points. The settings on this page are used to configure this process.

The screenshot shows the WebRelay Wireless XW-210 configuration interface. At the top left is the WebRelay Wireless logo, and at the top right is the model number XW-210. Below the logo is a navigation menu with tabs: Main, WiFi Networks (selected), Password, Date/Time, Logging, Input, Relays, Sensor, Script, Control Page Setup, and Control Page. The main content area is titled 'WiFi SETTINGS' and is divided into several sections:

- WiFi Settings:** SSID: wireless Strength: 100% Refresh; Security: Open WEP WPA/WPA2; Security Key: [masked]
- IP Settings:** Use DHCP: Yes No; HTTP Port: 80
- Remote Services:** Enabled: Yes No
- Modbus:** Enabled: Yes No
- Email Settings:** SMTP Server: [text box]; SMTP Server Port: 25 None; User Name: [text box]; Password: [masked]; Return Email: [text box]; Email 1-8: [text boxes]; Email Content: Full State Trigger Only; Test Email button

At the bottom of the form are buttons for Submit, Submit & Reboot, and Reset Changes.

Note: Reboot required for all network settings to take effect.

WiFi SETTINGS

SSID

The SSID (Service Set Identifier) is the name of the Wi-Fi network you wish the WebRelay Wireless module to connect to. Click the *Refresh* button to make a fresh scan of available networks. *Note: The Refresh button is inactive if the module is in access point mode.* The drop-down list shows each Wi-Fi network discovered together with its signal strength.

Security

Type of authentication used by the access point for connections.

Security Key

Enter the security key or password for the Wi-Fi network to connect to (hidden when not applicable.)

IP SETTINGS

Use DHCP

This option allows DHCP to be enabled or disabled. If this option is set to *Yes*, the WebRelay Wireless will wait for an IP address from a DHCP server each time it is powered. The default setting is *No* (this is recommended for most installations). If DHCP is set to *Yes*, the Network page must be submitted and the WebRelay Wireless must be rebooted before an IP address will be assigned. Once the module is assigned an IP address by the DHCP, the new IP address can be found through the clients list kept by the DHCP server. For most instances, this is found on the local gateway or router. Alternatively, the device will broadcast its information via mDNS.

Brief Notes About DHCP

All devices on an IP network require an IP address. This is a unique address that identifies each device on the network. DHCP (Dynamic Host Control Protocol) is a mechanism that automatically assigns an IP address to a computer (or other devices) when it is connected to a network. This eliminates the need to manually enter the IP address. When a computer is connected to the network, another device on the network called a DHCP server detects the presence of the computer and dynamically assigns the IP address to that computer. On many small networks, the DHCP server is built into the router.

DHCP works well for "client" devices such as computers, but is not ideal for servers. This is because servers usually don't initiate communications with other devices, but rather they wait for a request from "clients." To make this request, the client must know the IP address of the server. If a server gets its IP address dynamically, the IP address may not always be the same so client devices may not be able to find the server. For this reason, servers usually use an IP address that is fixed and does not change. The WebRelay is a server and manual IP address assignment is usually recommended.

IP Address

Enter the IP address for the WebRelay Wireless in this field. The IP address is specific to the network where the module will be installed and is obtained from the network administrator. The default setting for this field is 192.168.1.2.

Subnet Mask

The subnet mask defines the size of the local network. This can be obtained from the network administrator. For additional information about sub-netting and IP networking, many tutorials are available on the Internet. The default setting for this field is 255.255.255.0.

Gateway

This specifies the IP address of the gateway router. This can be obtained from your network administrator. The default setting for this field is 192.168.1.1.

DNS Server

The IP address of the DNS server is specified here. When DNS services are required, this is the address that will be used. The default setting for this field is 192.168.1.1. An alternate DNS server is not supported.

HTTP Port

The TCP port used for HTTP communications with the WebRelay Wireless module can be customized here. The default setting for this field is 80, which is the standard HTTP port. It is recommended that the port be left unchanged unless the user has an understanding of TCP/IP and ports.

REMOTE SERVICES

If Remote Services is enabled, the WebRelay Wireless will immediately attempt to make a connection with the remote server (power cycle not required). Once a connection is established, the connection will remain until it is disconnected by the remote server. If the connection is lost, it will automatically reconnect according to the *Connection Interval*.

REMOTE SERVICES	
Enabled:	Yes <input checked="" type="radio"/> No <input type="radio"/>
Hostname / IP Address:	<input type="text" value="devices.controlbyweb.cloud"/>
Remote Services Port:	<input type="text" value="8000"/>
Connection String:	<input type="text" value="[00:0C:C8:00:00:00]: ControlByWeb,XW-210"/>
Connection Interval:	<input type="text" value="1"/> Minutes
Version:	1.0 <input type="radio"/> 2.0 <input checked="" type="radio"/>
Use SSL Certificate:	Yes <input checked="" type="radio"/> No <input type="radio"/>
Certificate Request Token:	<input type="text"/>
Certificate Request Port:	<input type="text" value="443"/>
Manual Certificate Upload:	<input type="button" value="Client Certificate"/> <input type="button" value="Client Key"/> <input type="button" value="Client CA"/>

Hostname / IP Address

The URL or IP address of the server you wish to send (push) data to. If the IP address is specified, enter it in this format aaa.bbb.ccc.ddd. For numbers that are less than 100, preceding zeros should not be included (for example, enter 80 rather than 080). This field can be up to 40 characters long and has no default setting.

Remote Services Port

The TCP port used for communications with the remote server. This can be set within the range of 1-65535. The default setting for this field is 8000.

Connection String

This text is sent to the Remote Services server when the connection is established. This string should include any information required by the server at connection. For example, it may include an ID number, customer number, password, etc. The format is entirely dependent upon the server requirements. This field can be up to 80 characters long. Default text is provided only as an example placeholder. The default text is [`<Serial Number>`]:ControlByWeb,XW-210.

Connection Interval

This field specifies the periodic interval in which the WebRelay Wireless attempts to connect to the remote server, or if it is already connected, it is the interval in which the module sends the connection string. The default setting is 1 minute.

Version

This field specifies the version of the remote services' protocol to use. Version 1 of the protocol sends the connection string after successfully connecting to the remote server and then periodically per the connection interval specified. Version 2 of the protocol sends the connection string in addition to the MAC address, connection interval, model number and then immediately sends the state.xml file of the device. Version 2 of the protocol requires the remote server to reply to the connection string with a 3 byte packet containing the text "ACK". If the "ACK" is not received within 10 seconds of sending the connection string, the WebRelay Wireless will close the connection. Version 2 continues to send the connection string and the state.xml file periodically per the connection interval specified.

Use SSL Certificate

This option enables encryption of the remote services' connection with the remote services' server as well as authentication of the WebRelay Wireless to the server by a client certificate and key. Custom certificates and keys can be loaded into the module for this purpose. (See *Remote Services* at the end of this section for more information.)

By default, the WebRelay Wireless does not come with any SSL certificates already installed. The certificates will need to be installed either manually by uploading the files or automatically with a token. The SSL certificates must be in the PEM format.

Certificate Request Token

When the WebRelay Wireless has a valid Certificate Request Token entered, it will automatically attempt to request and download its Client Certificate, Key, and CA. Once successful, the token will be erased and the module will stop its requests. (See *Remote Services* at the end of this section for more information.)

Certificate Request Port

The certificate server is a server that has been configured to deliver the Client Certificate, Key, and CA when requested by the WebRelay Wireless module. For the module to request a Certificate, Key, and CA from the certificate server, it must have a previously issued Certificate Request Token. This field specifies what port the Certificate Server listens on. The server is found at the same host name as the remote services' server. (See *Remote Services* at the end of this section for more information.)

Manual Certificate Upload

Client Certificate

A client certificate is used with custom remote services' servers for device authentication. To upload a custom client certificate to the WebRelay Wireless, click the *Browse* button, find the PEM formatted certificate file, and select *Submit*.

Client Key

A client key is used with custom remote services' servers for device authentication. The key that is uploaded must be the correct key associated with the Client Certificate. Care should be taken with where this client key is stored as it is meant only to be known to the WebRelay Wireless module. To upload a custom client key to the module, click the *Browse* button, find the PEM formatted file, and select *Submit*.

Client CA

A CA (Certificate Authority) is used by the WebRelay Wireless to verify the authenticity of the remote services' server it is connecting to. It is important to note that this CA does not need to be the CA that signed the Client Certificate used by the WebRelay Wireless. Rather the CA needs to be the one used to sign the certificate used by the remote services server. To upload a custom CA to the WebRelay Wireless, click the *Browse* button, find the PEM formatted file, and select *Submit*.

Remote Services Notes: Remote services initiates an outgoing connection to a server at a remote location. This can be used in an environment where a web server on the Internet provides a custom web page to WebRelay Wireless module and other ControlByWeb products. Users access the module through the web server rather than communicating directly with it. This method is sometimes referred to as "web services" and allows programmers to create powerful, custom web pages to multiple devices using the web programming languages of their choice.

Remote services initiates the connection to the external web server (rather than the web server initiating communications to the WebRelay Wireless). This has two main benefits. First, the web server does not need to know the IP address of the WebRelay Wireless module. This means the module can get its IP address dynamically from a DHCP server, simplifying the installation. Second, since the connection from the WebRelay Wireless module is outgoing, rather than incoming, the local router on the network where the module resides doesn't need to be configured to forward sockets. This simplifies the installation. Since the router configuration is not modified, the risk of compromising security on the local network is eliminated.

MODBUS/TCP

The WebRelay Wireless can support Modbus/TCP. Modbus is a messaging structure protocol used in industrial manufacturing control and automation. It is an open protocol and offers interoperability with

software and devices from other manufacturers. (See Modbus/TCP.)

Note: Modbus communications are disabled whenever the Control Password is enabled.



MODBUS	
Enabled:	Yes <input checked="" type="radio"/> No <input type="radio"/>
Modbus Port:	<input type="text" value="502"/>
Endianness:	Big <input type="radio"/> Little <input checked="" type="radio"/>

Modbus Port

This specifies the port used for Modbus/TCP communications with the WebRelay Wireless. By default this is set to port 502 which is the standard Modbus port. It can be set within the range of 1 to 65535.

Endianness

32-bit data is treated as two individual 16-bit words using IEEE 754 floating point format. Floating point format is used for sensor data and pulse counter as well as for setting output pulse duration.

When the WebRelay Wireless module is set for big-endian architecture, the most significant 16-bit word (big end) is sent first. Otherwise the module will use little-endian architecture, and the least significant word (little end) is sent first. The default setting for this is little-endian.

For example, in little-endian format, a 32-bit floating point number represented by '1234 ABCD' is sent as 'ABCD1234'

EMAIL SETTINGS

An email can be sent when a temperature alarm or digital event occur. A BASIC script can also initiate an email message. This section is used to configure the email settings for up to eight email addresses. The same message is sent to each email address. For email notification to work, the WebRelay Wireless module must have a properly configured network connection and a SMTP server must be defined. Emails only work if the module is connected to an access point and can send messages on the internet.

Email triggers can be generated within a BASIC script (see Basic Scripts), or can be explicitly defined for each Sensor, Input, and Relay. The email options and recipients for each Sensor, Input, and Relay are configured separately. For each Sensor, Input, and Relay select the Email Option and the check box for the desired email recipient.

SMTP Server

The SMTP mail server host name.

SMTP Server Port

The port number of the SMTP mail server. This is generally 25 for non encrypted SMTP servers. If using SSL/TLS, this port number is generally 465.

SSL

Check this check box if the server and port you have configured is expecting a SSL connection.

User Name

Email user name (if required).

Password

If the SMTP mail server requires authentication, the password must be entered here. There is no default setting for this field.

Return Email

The WebRelay will not receive email messages, but when the WebRelay sends email messages, it must include a return email address. This field is used to specify the return email address. Note that although the WebRelay will send email messages with any email address specified in this field, some email filters (spam filters) will not allow messages through that include an invalid email address. There is no default setting for this field.

Email 1-8

When an alert occurs an email message is sent to this address.

Email Content

When "Full State" is selected, all visible fields in the control page will be included in the email message to be sent out. "Trigger Only" only includes the status of the I/O that triggered the email alert to be sent. Short messages can be easier to read when sent to cell phones as text messages.

Test Email

Pressing this button will submit any changes to the email settings and trigger an alert email to be sent to the configured email addresses. The result of the test email will be displayed next to this button once the attempt has been completed. The *Test Email* button is disabled if the device is in the Access-point mode.

The following are typical responses you may see along with a description of what they mean:

- Error initiating communications: Did not receive the expected HELO from SMTP server. Ensure you are using the proper port and host/IP settings.
- Error with EHLO: Error sending or error receiving proper response to the SMTP EHLO command. Server may be unavailable or port and IP address settings are not correct.
- Error authenticating: Error sending or error receiving proper response to the SMTP AUTH PLAIN command. This may indicate the use of an incorrect username or password.

- Error with FROM field: Error sending or error receiving proper response to the SMTP MAIL FROM command. Ensure the Return Email address has been properly specified.
- Error with RCPT(To) field: Error sending or error receiving proper response to the SMTP RCPT TO command. Ensure the To email addresses are using valid characters and formatted properly.
- Error sending DATA command: Error sending or error receiving proper response to the SMTP DATA command. This error generally indicates a problem with the SMTP server.
- Error sending message body: Error sending or error receiving proper response to sending the content of the email. This error generally indicates a problem with the SMTP server.
- Error resolving DNS: Error resolving the hostname in the SMTP Server field on the setup pages. If this field is an IP address, ensure no numbers are greater than 255, there are four numbers separated by dots, and there are no alphabetic characters. If the SMTP Server field is a host name, ensure the DNS Server on the WiFi Networks tab or DNS server issued via DHCP is valid and has a proper DNS record for the SMTP Server host provided.
- Error establishing connection: Error configuring security on SSL socket or error creating socket.
- Error with SSL handshake: Could not successfully negotiate a cipher or protocol version to use for the SSL connection to the SMTP server. Ensure the configured port is indeed expecting an SSL connection.
- No SMTP server configured: No valid SMTP Server has been specified. Enter the host name or IP address of the SMTP Server you would like to use.
- No To address configured: No recipients of the email alerts has been configured. Enter at least one email address into any of the Email fields.
- Success: The test email was sent successfully.

Note: When the WebRelay Wireless module is in Access Point mode, your smart-phone or computer connects directly to it and the module is not connected to the Internet. In this mode, no email messages can be sent and the Test Email button is disabled.

4.3 Password Tab

The WebRelay Wireless has separate passwords for the Setup and Control pages. The passwords can be changed on this page. The username (admin) is fixed and cannot be changed.

Main WiFi Networks Password Date/Time Logging Input Relays Sensor Script Control Page Setup Control Page

SETUP PAGE

Setup Password: [masked]
Re-enter Setup Password: [masked]

CONTROL PAGE

Enable Control Password: Yes No
Control Password: [masked]
Re-enter Control Password: [masked]

Submit Reset Changes

SETUP PAGE

Setup Password

The Setup Password, which is required to access the setup pages, can be modified by entering a new password here. Passwords that are 8 characters or longer (up to 13 characters can be entered in this field) with both alphabetic and numeric characters are recommended. For security purposes, the password will not be displayed as it is entered. Note: the username required for accessing the setup pages is `admin` (all lower case). The default Setup Password is `webrelay` (all lower case).

Re-enter Setup Password

When the Setup Password is changed, it must be entered twice. One time in the previous field and a second time in this field. If the password is not entered identically in both fields, the password will not be changed.

CONTROL PAGE

Enable Control Password

The Control Page is normally viewed without entering a password. For security purposes, a password can be enabled. When this field is set to `Yes`, a password will be required to view the control page. The default setting for this field is `No`.

Note: Since Modbus has no provision for passing passwords, the Control Page Password will disable Modbus if it is enabled.

Control Password

The password for the control page can be modified by entering a new password here. Passwords that are 8 characters or longer (up to 13 characters can be entered in this field) with both alphabetic and numeric characters are recommended. For security purposes, the password will not be displayed as it is entered.

Re-enter Control Password

When the Control Password is changed, it must be entered twice for verification. If the password is not entered identically in both fields, the password will not be changed.

4.4 Date/Time Tab

The WebRelay Wireless module uses the time of day for logging (a time stamp is included with each logged event.) The time is stored and displayed in 24-hour time format. The module does not have an event scheduler. The time in the WebRelay Wireless is not battery backed and will be lost if the device loses power. For this reason, it is recommended to use NTP as it will retrieve the time from the NTP server at power-up.

Current Date/Time

This is the current date and time stored in WebRelay Wireless. The time is stored and displayed in 24-hour format.

DATE/TIME SETTINGS

Set Time

This drop-down list offers two options for setting the time: *Manually* or *Sync with NTP server*.

The options that follow this field will change based upon how this option is set.

Manually: Requires the user to enter the time and date.

Sync with NTP server: Allows the user to set the clock automatically by using an NTP (Network Time Protocol) server.

MANUAL TIME CONFIGURATION

Date

The current date is entered by first selecting the correct month and year, using the left and right arrows at the top of the calendar. The single arrows(< and >) change the month and the double arrows (<< and >>) change the year. Once the current month and year are displayed, select the correct day, which will then be highlighted.

Time (24-Hour Format)

Enter the time as HH:MM:SS. (HH represents hours in 24-hour format [00-23], MM represents minutes [00-59], SS represents seconds [00-59].)

SYNC WITH NTP SERVER

Main	WiFi Networks	Password	Date/Time	Logging	Input	Relays	Sensor	Script	Control Page Setup	Control Page
----------------------	-------------------------------	--------------------------	---------------------------	-------------------------	-----------------------	------------------------	------------------------	------------------------	------------------------------------	------------------------------

Current Date/Time:	Fri, 01 Jan 2016 08:57:14
DATE/TIME SETTINGS	
Set Time:	Sync with NTP server ▾
Server Name/IP Address:	<input type="text"/>
Sync With Server:	Once <input checked="" type="radio"/> Daily <input type="radio"/> Weekly <input type="radio"/> Monthly <input type="radio"/>
UTC Offset (HH:MM):	-7 : 00
DAYLIGHT SAVINGS	
Daylight Savings Enabled:	Yes <input type="radio"/> No <input checked="" type="radio"/>
<input type="button" value="Submit"/> <input type="button" value="Reset"/>	

Server Name/IP Address

This field is used to specify the name or IP address of the NTP server. If a name is specified, a working DNS server address must be entered into the WiFi Network tab. If the IP address is specified, it should be entered in the following format aaa.bbb.ccc.ddd where each of the letters represents a number between 0 and 255. This field can be up to 40 characters. There is no default value for this field.

Many NTP Internet servers are available. In addition, many desktop computers will function as an NTP server (both Mac and PC). If a desktop computer is used, firewall settings may need to be adjusted to allow for NTP communications on UDP port 123.

Public NTP servers can be found at www.pool.ntp.org. Some of these are listed below.

US Servers (<http://www.pool.ntp.org/zone/us>):

- 0.us.pool.ntp.org
- 1.us.pool.ntp.org
- 2.us.pool.ntp.org
- 3.us.pool.ntp.org

North America (<http://www.pool.ntp.org/zone/north-america>):

- 0.north-america.pool.ntp.org
- 1.north-america.pool.ntp.org
- 2.north-america.pool.ntp.org
- 3.north-america.pool.ntp.org

Europe (<http://www.pool.ntp.org/zone/europe>):

- 0.europe.pool.ntp.org
- 1.europe.pool.ntp.org
- 2.europe.pool.ntp.org
- 3.europe.pool.ntp.org

Australia (<http://www.pool.ntp.org/zone/au>):

- 0.au.pool.ntp.org
- 1.au.pool.ntp.org
- 2.au.pool.ntp.org
- 3.au.pool.ntp.org

South America (<http://www.pool.ntp.org/zone/south-america>):

- 0.south-america.pool.ntp.org

- 1.south-america.pool.ntp.org
- 2.south-america.pool.ntp.org
- 3.south-america.pool.ntp.org

Africa (<http://www.pool.ntp.org/zone/africa>):

- 1.africa.pool.ntp.org
- 1.pool.ntp.org
- 3.pool.ntp.org

Sync With Server

This option allows the user to specify how often the time in the WebRelay Wireless module will be synchronized with the time server. When the Submit button on this page is pressed, the module will immediately synchronize with the time server. If Daily, Weekly, or Monthly options are selected, the WebRelay Wireless will thereafter re-synchronize with the time server at the period interval specified starting at the time of day the settings were submitted. The default value of this setting is Once (the unit will immediately sync with the NTP server, but will not automatically sync again until power cycled).

UTC Offset

Time servers return the current time in Universal Time (GMT). It is common for many servers and data loggers to use GMT as their official time, even when they are not located within the GMT time zone. The default value for this field is -7 (Mountain Standard Time). For convenience, the time can be converted to local standard time by entering the offset here. This manual cannot include the UTC Offset for all parts of the world, but the offset for GMT time and the four major US Time zones are listed here.

- GMT Time: 00:00
- Eastern Standard Time: -5:00
- Central Standard Time: -6:00
- Mountain Standard Time: -7:00
- Pacific Standard Time: -8:00

DAYLIGHT SAVINGS

Daylight Savings Enabled

In many parts of the United States and in some other countries, the time is shifted forward by one hour during the summer months. This is an effort to conserve energy by making the daylight last longer into the evening hours. If this option is set to Yes, the time in the WebRelay Wireless will automatically be shifted forward by one hour between the hours of 12:00 AM – 5:00 AM on the Daylight Savings Start date set below, and it will shift back to standard time between the hours of 12:00 AM – 5:00 AM on the Daylight Savings End date set below. The time change is made at a random time within the previously mentioned, five-hour time frame, in order to prevent several different devices from simultaneously requesting a time and overwhelming the NTP server. The default setting is Yes.

Note: Logged data includes a time stamp based upon the current time in the device, so it is possible to duplicate log times in the spring and miss log times in the fall. To avoid confusion, many servers and data loggers are set to remain on GMT time and do not shift for daylight savings.

Daylight Savings Start

This is the date that daylight savings will start. Note that on this date, between the hours of 12:00 AM – 5:00 AM, the current time will be shifted forward by one hour (i.e. the time will jump from 12:02 AM [00:02] to 1:02 AM [01:02]). By default this is set to the 2nd Sunday in March which is the date used in the United States.

Daylight Savings End

This is the date that daylight savings will end. On this date, between the hours of 12:00 AM – 5:00 AM, the current time will be shifted backward by one hour (i.e. time will jump from 12:02 AM [00:02] to 11:02 PM [23:02] the day before). By default this is set to the 1st Sunday in November which is the date used in the U.S.

4.5 Logging Tab

The WebRelay Wireless can be configured to record data such as sensor data and changes in I/O state. Both periodic and event-based logging are supported. The logged data is stored in internal nonvolatile memory and can be retrieved by entering the command `http://{XW-210 IP address}/log.txt`. For more information on logging, see LogFile.

The log is stored in non-volatile flash memory using a circular buffer (old data is over written). 512-Kbytes of memory space is reserved for logging. Log entries are composed of the following components, 5-byte header, 4-byte time stamp and 4 bytes for each sensor selected, 1-byte for input, 4-bytes for the counter, 1-byte for relay and 4-bytes for Vin. A log of Vin 1 (4 bytes) and the digital input (1 byte) will occupy 14 bytes per entry.

Note: Changing the log settings will erase the current log file.

Main
WiFi Networks
Password
Date/Time
Logging
Input
Relays
Sensor
Script
Control Page Setup
Control Page

Logging Enabled: Yes No

LOGGING SETUP

Start Time: 01 : 00

Logging Rate: 60 Mins Hours Days Event Logging Only

Sensor Trigger Delta: 2.0 When event trigger is selected and the sensor value changes by this amount, a log entry will be generated.

	Log	Event Trigger
Sensor 1	<input checked="" type="checkbox"/>	<input type="checkbox"/>
Sensor 2	<input checked="" type="checkbox"/>	<input type="checkbox"/>
Sensor 3	<input checked="" type="checkbox"/>	<input type="checkbox"/>
Sensor 4	<input checked="" type="checkbox"/>	<input type="checkbox"/>
Relay	<input checked="" type="checkbox"/>	<input type="checkbox"/>
Input	<input checked="" type="checkbox"/>	<input type="checkbox"/>
Counter	<input checked="" type="checkbox"/>	<input type="checkbox"/> 10.0
Vin	<input checked="" type="checkbox"/>	<input type="checkbox"/> 0.5

LOG EMAIL SETUP

Daily Email Log Send Time: 00 : 00

Use Email Address:

Logging Enabled

When this option is set to Yes, the WebRelay Wireless will record data as configured on this page. The default setting for this option is No.

LOGGING SETUP

Start Time

If a logging interval is specified (periodic logging rather than event logging), logging will occur relative to this start time. For example, if the start time is 01:00 and the logging rate is 6 hours, logging will occur at 01:00, 07:00, 13:00, and 19:00. Start time is specified in 24-hour time format. The default setting for this field is 01:00.

Logging Rate

This field is used to specify the time period of logging. A numerical value is entered into the text field, and the unit of time is selected using the adjacent radio buttons. The range of values in this field is 1-20864. Time units are *Minutes*, *Hours*, and *Days*. Periodic logging can be disabled by selecting the Event Logging Only radio button.

Sensor Trigger Delta

The WebRelay Wireless can be configured to log data when the count, voltage, temperature, or humidity measured by a sensor changes by the amount specified in this field. This can be set from 1.0 to 9999 units, in 0.1 increments. The default setting for these fields is shown below.

Sensor	Trigger Delta
Vin	2.0 V
Temperature	2.0°
Humidity	2.0%
Counter	2 counts

Logging Configuration

Check the items you wish to log. Check the event trigger box if the corresponding I/O should be allowed to cause the I/O state to be logged. For example, if the check box for the relay in the Event Trigger column is checked, a log entry will be entered each time the relay changes state even if the log is configured to only log periodically. Log entries recorded due to an event will not interfere with periodic logging.

LOGGING EMAIL SETUP**Daily Email Log Send Time**

The WebRelay Wireless can periodically Email the log file at a specific time. For example, use this feature to email the temperature log of a restaurant food cooler once per day to provide the documentation required for health regulations.

Use Email Address:

These check boxes determine which Email addresses the periodic data log is sent to. Up to eight email addresses can be assigned. The same data log is sent to each Email address. For Email notification to work, the WebRelay Wireless must have a properly configured network connection and a SMTP server must be defined. When an Email address is entered via the *WiFi Networks tab*, the check boxes will show the respective Email addresses.

4.6 Input Tab

These settings determine how the WebRelay Wireless processes the digital input. The digital input has a counter which counts the number of input pulses. The input has a set debounce of 20ms before counters or events are processed. This page provides configuration options for the input and its counter.

Main WiFi Networks Password Date/Time Logging Input Relays Sensor Script Control Page Setup Control Page

INPUT SETTINGS

Input Description:
All settings refer to 'ON' when a voltage is applied to the input and 'OFF' when no voltage is applied.

On Status Text:

On Status Color: Green Red Yellow Blue Grey

Off Status Text:

Off Status Color: Green Red Yellow Blue Grey

Counter Options:

Description: Units:

Slope (Multiplier):

Offset:

Email Alert:

Use Email Address:

Remote Service: Send State Msg on Input Change

Input Description

This text is used to describe the function of the digital input. The text appears to the left of corresponding input status on the *Control Page*, and in email messages, when email alerts are enabled. This field may be up to 24 characters long. Enter a descriptive name such as “*Stockroom Door*”.

On Status Text

The text in this field specifies the text that will be displayed in the *Control Page* and in email messages when the input is ON (switch is closed). Up to 15 characters may be entered in this field. Enter a descriptive status such as “*Door Open*”.

On Status Color

This field specifies the color that will be displayed on the *Control Page* when the input is considered On. Options are Green, Red, Yellow, Blue and Grey.

Off Status Text

The text in this field specifies the text that will be displayed in the *Control Page* and in email messages when the input is Off (switch is open). Enter a descriptive status such as “*Door Closed*”.

Off Status Color

This field specifies the color that will be displayed on the *Control Page* when the input is considered Off. Options are Green, Red, Yellow, Blue and Grey.

Counter Options

This settings determines what triggers the counter to increment. The default setting for this field is: "Counter off".

Counter off: No input transitions will be counted.

Increment when input on: The counter will increment each time the input turns on.

Increment when input off: The counter will increment each time the input turns off.

Increment when input changes: The counter will increment each time the input changes on or off.

Description

This text field is used to describe the counter. The text appears to the left of the corresponding counter on the Control Page, and in email messages when email alerts are enabled. This field may be up to 9 characters long. The default text is "Count 1".

Units

This text field is used to describe the units counted. The text appears to the right of the counter reading. This field may be up to 4 characters long.

Slope (Multiplier)

The counter value can be scaled into engineering units. The WebRelay Wireless reads the raw value from the counter and calculates a new value in engineering units. This scaled value is calculated using a linear $Y=mX+b$ formula.

$$\text{Scaled Value} = \text{Slope} * \text{Count} + \text{Offset}$$

The calculated scaled value is used for trigger logs, email messages, control page, XML page, and returned when Modbus values are read.

The "slope" in the formula above is provided by the user and is entered in this field. When both the slope and offset are set to their default values ($m=1$ and $y=0$) the scaled value equals the actual count.

Offset

The "offset" in the formula above is provided by the user and is entered in this field. The default value for this field is 0.

Email Alert

Simple email messages can be sent in response to changes in the digital input. This setting is used to specify what conditions, if any, will cause email messages to be sent.

No email Messages: No email messages will be sent due to input conditions.

Send email when Input On: Email notifications will be sent when the input is on.

Send email when Input Off: Email notifications will be sent when the input is off.

Send email when Input Changes State: Email notifications will be sent when the input turns on or off.

Use Email Address

These check boxes determine which email addresses the input alert message is sent to. Up to eight email addresses can be assigned. The same message is sent to each email address. For email notification to work, the WebRelay Wireless must have a properly configured network connection and a SMTP server must be defined. When an email address is entered via the *WiFi Networks tab*, the check boxes will show the respective email addresses.

Remote Service

When this box "Send State Message on Input Change" is checked, State messages will be sent whenever the input state changes. Remote Services must be enabled and properly configured for this feature to be effective.

4.7 Relay Tab

XW-210

Main WiFi Networks Password Date/Time Logging Input Relays Sensor Script Control Page Setup Control Page

RELAY SETTINGS

Relay Description:
All relay references to 'ON' mean that relay is energized and normally open contacts are closed. References to 'OFF' mean that relay is not energized and normally open contacts are open.

On Button Label:
 Off Button Label:
 Pulse Button Label:

On Status Text:
 On Status Color: Green Red Yellow Blue Grey

Off Status Text:
 Off Status Color: Green Red Yellow Blue Grey

Pulse Duration: Seconds
 Relay State At Powerup:
 Control Source:

Email Alert:

Use Email Address:

Remote Service: Send State Msg on Relay Change

REMOTE RELAY

Control Source:
 Hostname / IP Address:
 TCP Port:
 Password:
 Relay #:
 Periodic State Interval:

Description

This text field is used to describe the function of the relay. The text appears to the left of the corresponding relay status on the *Control Page* and in the email message when email alerts are enabled. Up to 24 characters may be entered in this field. The default text is "Relay 1".

On Button Label

The text entered in this field appears in the 'On' button for the corresponding output on the *Control Page*. Up to 15 characters may be entered in this field. The default text is "ON".

Off Button Label

The text entered in this field appears in the 'Off' button for the corresponding output on the *Control Page*. Up to 15 characters may be entered in this field. The default text is "OFF".

Pulse Button Label

The text entered in this field appears in the 'Pulse' button for the corresponding output on the *Control Page*. Up to 15 characters may be entered in this field. The default text is "PULSE".

On Status Text

The text in this field specifies the text that will be displayed in the *Control Page* and in email messages when the relay is On. Up to 15 characters may be entered in this field. The default text is "ON".

On Status Color

This field specifies the color that will be displayed on the *Control Page* when the relay is considered on. Options are Green, Red, Yellow, Blue and Grey. The default color is Green.

Off Status Text

The text in this field specifies the text that will be displayed in the *Control Page* and in email messages when the relay is Off. Up to 15 characters may be entered in this field. The default text is "OFF".

Off Status Color

This field specifies the color that will be displayed on the *Control Page* when the relay is considered off. Options are Green, Red, Yellow, Blue and Grey. The default color is Red.

Pulse Duration

When WebRelay Wireless receives a pulse command for the relay (through the web page or through a command), the relay will pulse for the time specified in this field. Note that when a pulse command is sent through the command interface (XML or ModBus), the command can include a pulse time which will over-ride this value (for that pulse only). The time is specified in seconds and can range from 0.1 seconds to 86400 seconds in 0.1 second increments. The default time is 1.5 seconds.

Relay State at Power up

This drop-down menu lets the user specify the state of the relay when the WebRelay Wireless is powered up. The following options can be selected:

Off: The relay will be off upon power up (this is the default setting.)

On: The relay will be on upon power up.

Evaluate Logic: Upon power up, the control source and action are evaluated to determine the proper state of the relay.

Control Source

These drop-down menus specify what input or sensor controls the state of the relay. The following options can be selected:

None: The state of the relay will be controlled only by the web page.

Digital Input: The state of the relay will be controlled by the digital input and/or the web page.

1-Wire Sensor: The state of the relay will be controlled by a 1-Wire sensor and/or the web page.

Depending on the *Control Source* option, the menu will change.

If *Digital Input* is selected, the following *Action* options are available:

Set relay equal input: *When the input is on, the relay is on. When the input is off, the relay is off.*

Set relay opposite of input: *When the input is on, the relay is off. When the input is off, the relay is on.*

Latch relay on when input [on, off, changes] (reset via web): The relay latches on when the input is [on, off, changes]

Latch relay off when input [on, off, changes] (reset via web): The relay latches off when

the input is [on, off, changes]

Toggle relay when input [on, off, changes]: The relay changes state when the input is [on, off, changes]

Pulse relay when input [on, off, changes]: The relay is pulsed when the input is [on, off, changes]

If *1-Wire Sensor* is selected, choose the sensor number. For each sensor the following *Action* options are available:

Set Relay On: The relay turns on when [Alarm 1, Alarm 2, Alarm 1 or Alarm 2] is true

Set Relay Off: The relay turns off when [Alarm 1, Alarm 2, Alarm 1 or Alarm 2] is true

Latch Relay On: The relay latches on when [Alarm 1, Alarm 2, Alarm 1 or Alarm 2] is true

Latch Relay Off: The relay latches off when [Alarm 1, Alarm 2, Alarm 1 or Alarm 2] is true

Toggle Relay: The relay changes state when [Alarm 1, Alarm 2, Alarm 1 or Alarm 2] is true

Pulse Relay: The relay is pulsed when [Alarm 1, Alarm 2, Alarm 1 or Alarm 2] is true

Email Alert

Simple email messages can be sent in response to relay state changes. This parameter is used to specify what relay state changes, if any, will cause email messages to be sent. Note that email notification will work only if the email settings are correctly set up in the *Network* setup page. The following options are available:

No Email Messages: No email notifications will be sent due to relay state changes.

Send Email when relay on: Email notifications will be sent when relay state changes to on.

Send Email when relay off: Email notifications will be sent when relay state changes to off.

Send Email when relay changes state: Email notifications will be sent when relay changes state from off to on or on to off.

Use Email Address

These check boxes determine which email addresses the relay alert message is sent to. Up to eight email addresses can be assigned. The same message is sent to each email address. For email notification to work, the WebRelay Wireless must have a properly configured network connection and a SMTP server must be defined. When an email address is entered via the *WiFi Networks* tab, the check boxes will show the respective email addresses.

Remote Service

When this box "Send State Message on Relay Change" is checked, State messages will be sent whenever the selected source changes. Remote Services must be enabled and properly configured for this feature to be effective.

The digital input can be configured to control the relay contacts of another ControlByWeb™ device (such as the X-310™) at a remote location. The 'Remote Service Options' setting is used to specify if and how the input affects the remote relay. The options in the drop-down list are described below. Note that in all cases, input changes will only affect the remote relay at the time the input is changed. Once the change has taken place, the state of the input has no effect on the state of the remote relay. In other words, if

the input causes the remote relay to go on, a user may turn that remote relay off from the web browser, even if the local input is still on.

REMOTE RELAY

The WebRelay Wireless can be configured to control a relay on other ControlByWeb devices across the network. These relays are called remote relays.

Control Source:

Select the resource to control the remote relay. The following options are available:

None: *No commands are sent to a remote relay*

Digital Input: The state of the remote relay will be controlled by the digital input.

Relay: The state of the remote relay will be controlled by the local relay.

1-Wire Sensor: The state of the remote relay will be controlled by 1-Wire Sensor alarms.

Action

These drop-down menus specify what action to take when a criteria is met. The actions change depending on what control source has been selected. The following section lists the options available based for each control source selected.

If *Digital Input* is selected the following *Action* options are available:

Remote command equals input: When the input is on, a command is sent to the remote device to set the relay state to *on*. When the input is off, a command is sent to the remote device to set the relay state to *off*.

Remote command opposite of input: When the input is on, a command is sent to the remote device to set the relay state to *off*. When the input is off, a command is sent to the remote device to set the relay state to *on*.

Send on command when input [on, off, changes] (no off command): When the input is [on, off, changes] a command is sent to the remote device to set the relay state to on. No off commands are sent to the remote device.

Send off command when input [on, off, changes] (no on command): When the input is [on, off, changes] a command is sent to the remote device to set the relay state to *off*. No on commands are sent to the remote device.

Send toggle command when input [on, off, changes]: When the input is [on, off, changes] a command is sent to the remote device to toggle the relay (change the remote relay to the state opposite of its current state).

Send pulse command when input [on, off, changes]: When the input is [on, off, changes] a command is sent to the remote device to pulse the relay.

If *Relay* is selected the following *Action* options are available:

Remote command equals relay: When the local relay is on, a command is sent to the remote device to set the relay state to *on*. When the local relay is off, a command is sent to the remote device to set the relay state to *off*.

Remote command opposite of relay: When the local relay is on, a command is sent to the remote device to set the relay state to *off*. When the local relay is off, a command is sent to the remote device to set the relay state to *on*.

Send on command when relay [on, off, changes] (no off command): When the local relay is [on, off, changes], a command is sent to the remote device to set the relay state to *on*. No off commands are sent to the remote device..

Send off command when relay [on, off, changes] (no on command): When the local relay is [on, off, changes] a command is sent to the remote device to set the relay state to *off*. No on commands are sent to the remote device.

Send toggle command when relay [on, off, changes]: When the local relay is [on, off, changes] a command is sent to the remote device to toggle the relay (change the remote relay to the state opposite of its current state).

Send pulse command when relay [on, off, changes]: When the local relay is [on, off, changes] a command is sent to the remote device to pulse the relay.

If *1-Wire Sensor* is selected, choose the sensor number. For each sensor the following *Action* options are available:

Send On Command When [Alarm1, Alarm2, Alarm1 or Alarm2]: A command is sent to the remote device to set the relay state to on when [Alarm1, Alarm2, Alarm1 or Alarm2] becomes true. A command is sent to the remote device to set the relay state to off when [Alarm1, Alarm2, Alarm1 or Alarm2] becomes false.

Send Off Command When [Alarm1, Alarm2, Alarm1 or Alarm2]: A command is sent to the remote device to set the relay state to off when [Alarm1, Alarm2, Alarm1 or Alarm2] becomes true. A command is sent to the remote device to set the relay state to on when [Alarm1, Alarm2, Alarm1 or Alarm2] becomes false.

Send On Command When [Alarm1, Alarm2, Alarm 1 or Alarm2] (no off command): A command is sent to the remote device to set the relay state to on when [Alarm1, Alarm2, Alarm1 or Alarm2] becomes true. No off command is sent.

Send Off Command When [Alarm1, Alarm2, Alarm 1 or Alarm2] (no on command): A command is sent to the remote device to set the relay state to off when [Alarm1, Alarm2, Alarm1 or Alarm2] becomes true. No on command is sent.

Send toggle command when [Alarm 1, Alarm2, Alarm 1 or Alarm2]: A command is sent to the remote device to toggle the relay (change the remote relay to the state opposite of its current state when [Alarm1, Alarm 2, Alarm 1 or Alarm 2] becomes true.

Send Pulse Command When [Alarm1, Alarm2, Alarm1 or Alarm2]: A command is sent to the remote device to pulse the relay when [Alarm1, Alarm 2, Alarm 1 or Alarm 2] becomes true.

4.8 Sensor Tab

Up to four temperature or other Xytronix 1-Wire sensors can be connected to the WebRelay Wireless. Each of the 1-Wire sensors have specific settings. The settings for the first two sensors are shown below.

The screenshot shows the 'Sensor' tab in the WebRelay Wireless configuration interface. It features a navigation bar at the top with tabs for Main, WiFi Networks, Password, Date/Time, Logging, Input, Relays, Sensor (selected), Script, Control Page Setup, and Control Page. The main content area is divided into two sections, SENSOR 1 and SENSOR 2. Each section contains the following fields: Sensor Description (text input), Sensor Address (dropdown menu), Offset (text input), Alarm 1 (text input with radio buttons for High and Low), Alarm 2 (text input with radio buttons for High and Low), Deadband (text input), Email/Action Delay (text input with 'Seconds' label), Email Option (dropdown menu), Use Email Address (checkboxes), and Remote Services (dropdown menu).

Sensor Description

This text will appear in email messages when email alerts are enabled as well as to the left of the corresponding temperature/humidity value on the *Control Page*. This field may be up to 35 characters long.

Sensor Address

Each sensor connected to the WebRelay Wireless must be associated (assigned) to a sensor number. Every sensor comes from the factory with a unique, non-changeable address. When the sensors tab is selected, the WebRelay Wireless scans the bus for sensors. The addresses of the sensors that are found on the bus are listed in the drop-down list. For each sensor number (Sensor 1... Sensor 4), select

the address of the appropriate sensor from the drop-down list.

Selecting sensors is simplest when the sensors are connected to the bus one at a time. The procedure is to start with one sensor and associate it with the appropriate sensor number by selecting the sensor address within the appropriate drop-down list. Press *Submit*, then connect a second sensor, and press the *Sensors* tab. Associate the second sensor to the appropriate sensor number. Continue this procedure until all sensors are set up.

Offset

The value of the offset will be added to the sensor's reading. Normally this should be set to zero.

Alarm 1

This setting is used to set the trigger point for an alarm condition. The numeric field specifies the temperature/humidity at which the alarm is triggered. The "High" and "Low" radio buttons indicate whether the alarm is triggered as a high or low alarm. A high alarm is triggered when the sensor reading exceeds the alarm value, and a low alarm is occurs when the sensor reading falls below the alarm value.

Generally this value will be static, but a Register can be used as a trigger point for an alarm condition as well. To use a Register select the desired Register using the drop-down box. The value of a Register can be changed through a basic script, and directly through the control page.

Alarm 2

This is a second alarm trigger that works similarly to Alarm 1.

Deadband

The deadband (hysteresis) prevents alarms from triggering excessively when the measurement value vacillates around the trigger point. With high alarms, the measurement must fall below the high alarm point minus the dead band before the high alarm will be triggered again. Likewise the deadband on the low alarm requires the measurement to rise above the low alarm point plus the deadband before the low alarm will be triggered again.

For example, if the dead band is set to 0.5°C, and a high alarm is set at 13°C, the high alarm will occur at 13°C; however, it will not turn off until the temperature drops below 12.5°C (13°C - 0.5°C).

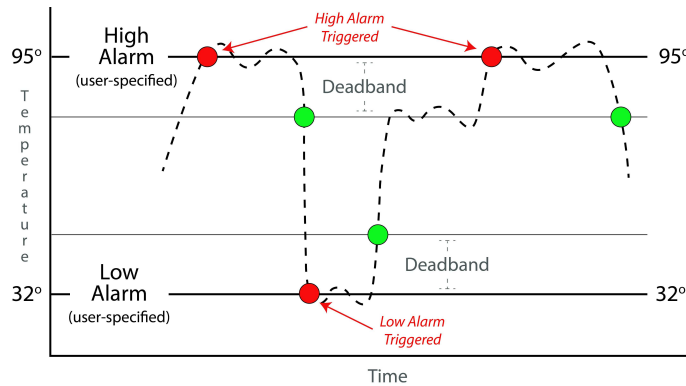

Email/Action Delay

Number of seconds to delay before considering the sensor to be in an alarm state. For example, if the temperature sensor is monitoring a freezer and is mounted near the door, the sensor may go in to an alarm state each time the door is opened and cause false alarms. The delay will cause the temperature to be in an alarm state for the specified number of seconds before processing any triggers based on that sensors alarm state.

Email Option

Simple email messages can be sent in response to alarm conditions. This parameter is used to specify what alarm conditions, if any, will cause email messages to be sent. Email notifications will work only if email is correctly setup in the *WiFi Networks* tab.

No email Messages: No email messages will be sent due to alarm conditions.

Send email on Alarm 1: Email notifications will be sent due to an Alarm 1 condition.

Send email on Alarm 2: Email notifications will be sent due to an Alarm 2 condition.

Send email on Alarm 1 and Alarm 2: Email notifications will be sent due to an Alarm 1 or Alarm 2 condition.

Send email on Alarm 1, Alarm 2 and normal: Email notifications will be sent when Alarm 1 or Alarm 2 occur, or when normal conditions are restored.

Use Email Address

These check boxes determine which email addresses the temperature alarm message is sent to. Up to eight email addresses can be assigned. The same message is sent to each email address. For email notification to work, the WebRelay Wireless must have a properly configured network connection and a SMTP server must be defined. When an email address is entered via the *WiFi Networks tab*, the check boxes will show the respective email addresses.

Remote Services

The WebRelay Wireless can be configured to send messages to other ControlByWeb™ products that are located at a remote location the network (or Internet). This field specifies the action taken due to a temperature alarm condition. The following actions are available:

No Action: No action is taken.

Send state on Alarm 1: state.xml will be sent when Alarm 1 becomes true.

Send state on Alarm 2: state.xml will be sent when Alarm 2 becomes true.

Send state on Alarm 1 and Alarm 2: state.xml will be sent when Alarm 1 or Alarm 2 becomes true.

4.9 Script Tab

The WebRelay Wireless module can run custom programs written in a simplified version of BASIC. This page is used to load and execute these programs. Before it can be loaded to the module, a script must first be prepared as a .txt file. The file must then be uploaded to the WebRelay Wireless via the *Script* tab. The maximum size of script that can be uploaded to the device is 4-Kbytes. Information on writing a basic program for this module can be found in the Basic Scripts section.

An ASCII standard text file format should be used, such as Windows Notepad, Programmer's Notepad, vi, or other text editor that output the file as a .txt. Rich Text Format (.rtf) used by Microsoft WordPad is NOT compatible.

The screenshot shows the 'Script' tab interface. At the top, there is a navigation bar with buttons for 'Main', 'WiFi Networks', 'Password', 'Date/Time', 'Logging', 'Input', 'Relays', 'Sensor', 'Script' (which is highlighted), 'Control Page Setup', and 'Control Page'. Below this is a dark blue sidebar with the title 'BASIC SCRIPT'. The sidebar contains three sections: 'Current Script:', 'Interpreter Status:', and 'Upload BASIC Script:'. The 'Current Script:' section has a large white text area containing the text 'No Script Loaded.'. The 'Interpreter Status:' section has another large white text area. The 'Upload BASIC Script:' section has a 'Browse...' button and the text 'No file selected.'. Below the sidebar is a 'Run Script:' section with 'Yes' and 'No' radio buttons, where 'No' is selected. At the bottom of the interface are 'Submit' and 'Reset' buttons.

Current Script

This field displays the .txt file that is uploaded to the WebRelay Wireless. Text displayed in this screen cannot be edited. In order to edit any script, it must be rewritten in the .txt file and uploaded again.

Interpreter Status

This field displays whether the program is running, has stopped or finished, or if there are errors contained in the script. If there are errors in the script, the line on which the error occurred is displayed.

Upload BASIC Script

This field displays the script selected to be uploaded to the device. To upload a script to the WebRelay Wireless, click the *Browse* button, find the .txt file previously created, and select *Open*. The location of the file should appear in the neighboring field. To upload the script to the unit, select *Submit*.

Run Script

This option selects whether or not the selected script will be run after it has been uploaded. The *Submit* button must be clicked to run the script.

4.9.1 Example Script

The following is an example script which monitors a door switch. An alarm sounds after a door has been open for 10 seconds, and turns off if the door is closed. It includes a trigger to exit the timer if the input turns off before 10 seconds has elapsed. This helps insure that the alarm will only turn on if the door has been open for 10 seconds.

```
'This example will turn on a relay after an input has been on for 10 seconds

LET relay1 = 0                                'Make sure the relay is off when the script starts

DO                                             'Begin main program loop
  IF input1 = 1 THEN                          'Checks if input 1 is on - Door is open
    CALL delay                                'Calls the delay function
    IF input1 = 1 THEN                        'After the delay is done, it will check the door again
      LET relay1 = 1                          'Turns the relay on, sounding the alarm
    END IF
  ELSE                                         'If input1 is off - door is closed
    LET relay1 = 0                            'Turn relay1/alarm off after closed door
  END IF                                       'End of IF input1 = 1
LOOP                                          'Loop main program
END                                           'End main program loop

SUB delay                                     'SUB function
  LET t1 = 100                                'Set timer = 10.0 seconds
  DO WHILE t1 > 0                             'Loop while timer is counting down to 0.0 seconds
    IF input1 = 0 THEN                       'If the input turns off (door closed), exit loop
      LET t1 = 0                             'Sets timer to 0 to exit loop
    END IF                                   'End of IF input1 = 0
  LOOP                                       'Loop the DO WHILE statement above
END SUB                                       'End of the SUB routine
```

4.10 Control Page and Register Setup Tab

The *Control Page Setup* page is used to set parameters that affect the view of the *Control Page*, including what measurement values and buttons are to be shown.

XW-210

Main WiFi Networks Password Date/Time Logging Input Relays Sensor Script Control Page Setup Control Page

CONTROL PAGE SETUP

Module Description:

Refresh Rate: Seconds

	Display Temperature/State	Display Counter	Display Counter Reset Button	Display On/Off Buttons	Display Pulse Button
Relay	<input checked="" type="checkbox"/>			<input checked="" type="checkbox"/>	<input checked="" type="checkbox"/>
Input	<input checked="" type="checkbox"/>	<input type="checkbox"/>	<input type="checkbox"/>		
Sensor1	<input checked="" type="checkbox"/>				
Sensor2	<input type="checkbox"/>				
Sensor3	<input type="checkbox"/>				
Sensor4	<input type="checkbox"/>				
Register1	<input type="checkbox"/>			<input type="checkbox"/>	
Register2	<input type="checkbox"/>			<input type="checkbox"/>	
Register3	<input type="checkbox"/>			<input type="checkbox"/>	
Register4	<input type="checkbox"/>			<input type="checkbox"/>	

REGISTER 1

Description:

Button 1 Label:

Button 2 Label:

Status 1 Text:

Status 2 Text:

REGISTER 2

Description:

Button 1 Label:

Button 2 Label:

Status 1 Text:

Status 2 Text:

REGISTER 3

Description:

Button 1 Label:

Button 2 Label:

Status 1 Text:

Status 2 Text:

REGISTER 4

Description:

Button 1 Label:

Button 2 Label:

Status 1 Text:

Status 2 Text:

Module Description

The text entered here appears at the top of the *Control Page*. It also appears in the header of the email text when the email notification is used. This field can be up to 40 characters in length. The default text is "XW-210".

Refresh rate

How often the Control Page status is updated. The default value is 3 seconds.

Display Configuration

These check boxes select which input/output resource is displayed on the control page. Each check box determines whether or not the status of the resource is displayed.

Relay: Determines if the relay status and/or what buttons are visible on the control page.

Input: Determines if the input status is visible on the control page.

Display Counter: Determines the visibility of the counter value on the control page.

Sensors (1-4): Determines the visibility of the 1-Wire sensor readings on the control page.

Registers (1-4): Determines the visibility of the registers on the control page.

Registers:

Registers can be changed externally thru the *Control Page*, *XML requests* or the BASIC script. This allows a BASIC script to react to user input. These variables are considered to be floating point numbers, just like other variables in the BASIC script. This section has settings for each of the registers.

Description

Text entered here will be displayed in the left column of the control page. Up to 14 characters may be entered here. The default text is "Register 1".

Button 1 Label

This text field is used to describe the function of button 1 of the selected Register. When the user clicks button 1, the Register is set to 1. The text also appears to the right of the corresponding Register status. Up to 9 characters may be entered here. By default, this text is "ON".

Button 2 Label

This text field is used to describe the function of button 2 of the selected Register. When the user clicks button 2, the Register is set to 0. The text also appears to the right of the corresponding Register status. Up to 9 characters may be entered here. By default, this text is "OFF".

Status 1 Text

The text in this field specifies the text that will be displayed when the Register is value 1. The text also appears in the status column on the *Control Page*.

If the Register is any other value than 1 or 0, the value itself will be displayed in the same column. Up to 9 characters may be entered here. By default the text is "ON"

Status 2 Text

The text in this field specifies the text that will be displayed when the Register is value 0. The text also appears in the status column on the *Control Page*.

If the Register is any other value than 1 or 0, the value itself will be displayed in the same column. Up to 9 characters may be entered here. By default the text is "OFF".

Section 5: Control Page

The relay, digital input and temperature sensors can be monitored and controlled using a web browser, by sending text commands to an XML status/control page, and/or by sending Modbus/TCP requests.

5.1 Browser Operation

Once the WebRelay Wireless is set up, users can access the *Control Page* using a web browser. There are two ways to do this. The first is by typing the IP address of the WebRelay Wireless module directly into the web browser address bar. For example, using the default IP address, the user would enter `http://192.168.1.2`. If the IP address is changed from the default, the user must use the new IP address. Note that if any port is used other than the default port 80, the port must also be included in the request. For example, accessing the unit at port 8000 would be as follows: `http://192.168.1.2:8000`.

The following screen appears when the Control Page is requested from the address bar. This example has all of the optional resources enabled. The I/O on the control page updates every three seconds.

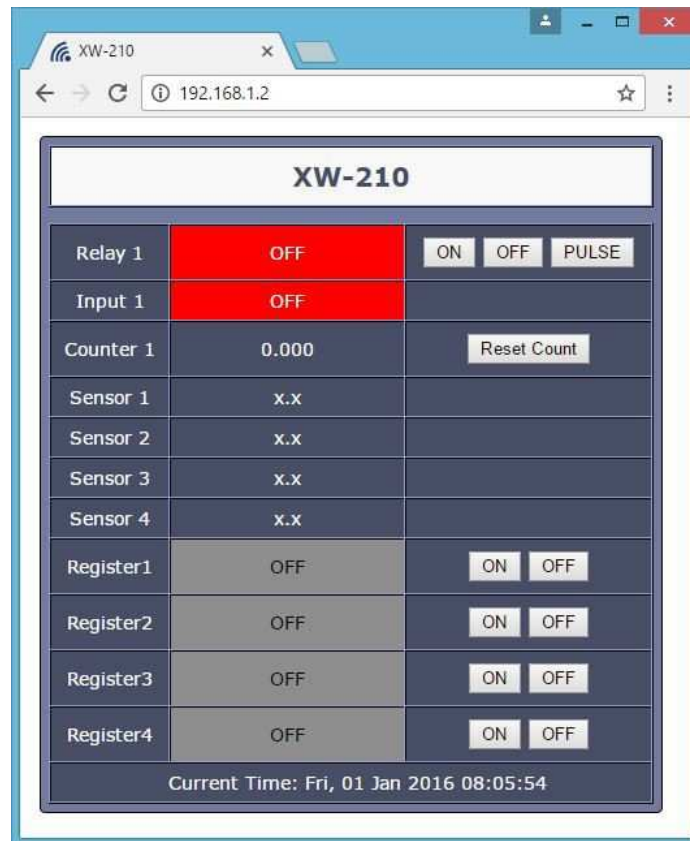

The Control Page is normally what users see and use, and it can be highly configured to fit your needs. The *Control Page Setup* tab has check boxes that determine if a specific resource is displayed or not. The description (text) shown for certain rows is also specified in the *Control Page Setup* tab.

Header

Displays the text entered in the *Module Description* text field on the *Control Page Setup* tab in the setup pages. This is usually a description of the application such as “2nd Floor Freezer”.

Input

This row displays the current state of the digital input. The text in the left column (by default reads “Input 1”) is specified in the description field of the *Input* tab in the setup pages.

Counter

A cumulative count of OFF to ON states of the digital input. A reset button can be enabled which resets the counter.

Relay

This row displays the current state of the internal relay and has buttons to allow the user to change the relay state. The text in the left column (by default reads “Relay 1”) is specified in the description field of the *Relay* tab in the setup pages. The state of the relay is shown to the right of the relay description text. By default, the status text will read ON or OFF; however, the status text can be changed in the *Relay* tab.

To the right of the relay status, three buttons provide on/off and pulse control of the relay. The buttons can be removed when not needed (in the *Control Page Setup* tab) and the text within the buttons can be customized (in the *Relay* tab).

Sensor 1-4

These fields display the current temperature or other values measured by the associated sensors. Each sensor has a description field specified in the Description field in the *Sensors* tab in the setup pages.

Registers

These rows display the current state of the four registers used in the BASIC script. The state of the register is shown to the right of the description text. By default the status text will read *ON* or *OFF* when the register is a value of 1 or 0 respectively. To the right of the register status, two buttons are provided to control the state of the register. These buttons can be enabled or disabled in the *Control Page Setup* tab.

5.2 Control Page Tab

The second method of accessing the control page is through the setup pages (<http://192.168.1.2/setup.html>). Clicking the *Control Page* tab will open a new browser window and display the Control Page shown below. To access the setup tabs again, click on the *WebRelay Setup* tab in your browser to return to the previous browser window.



Section 6: Auxiliary Operations

6.1 XML

Custom XML computer applications may be created to monitor and control the WebRelay Wireless. This method does not use a web browser. There is a single XML page that can be used to monitor and control the WebRelay Wireless: *state.xml*. The WebRelay does not support *diagnostics.xml*.

6.1.1 state.xml

XML Monitor All Functions

The state of the Relays, Inputs, Sensors, Registers, and Vin can be monitored by sending a request to port 80 (or port specified in setup). This can be demonstrated by entering the following URL into the address bar of a web browser (substituting the IP address as necessary):

```
http://192.168.1.2/state.xml
```

The following *state.xml* page is returned:

```
<datavalues>
  <input1state>0</input1state>
  <relay1state>0</relay1state>
  <units>F</units>
  <sensor1>x.x</sensor1>
  <sensor2>x.x</sensor2>
  <sensor3>x.x</sensor3>
  <sensor4>x.x</sensor4>
  <s1Alrm>0</s1Alrm>
  <s2Alrm>0</s2Alrm>
  <s3Alrm>0</s3Alrm>
  <s4Alrm>0</s4Alrm>
  <count1>23</count1>
  <register1>0.00</register1>
  <register2>0.00</register2>
  <register3>0.00</register3>
  <register4>0.00</register4>
  <vin>9.577</vin>
  <time>1343647469</time>
</datavalues>
```

The numbers enclosed by the tags, `<tag>`, indicate the current state or value monitored by the WebRelay Wireless. Values for each tag are described in the table below.

XML computer applications will open a TCP/IP socket with the WebRelay Wireless and send a `GET` command followed by the *state.xml* command string. (See HTTP GET Requests (for custom applications) for instructions on using GET.)

XML Tags*	Monitor Values
<code><input1state></code>	0=off (voltage not applied to input one) 1=on (voltage applied to input one)
<code><relay1state></code>	0=off (coil one off) 1=on (coil one energized)

XML Tags*	Monitor Values
<units>	F=Fahrenheit C=Celsius
<sensorX>	x.x = Indicates that no sensor reading is available 77.3 = Current sensor reading
<sXAlarm>	Current state of the sensor alarms 0 = Normal 1 = Alarm 1 2 = Alarm 2
<count1>	The scaled count value (rawCount * multiplier + offset).
<registerX>	Value of each Register.
<vin>	Scaled internal Vin measurement
<time>	Time displayed in "epoch time" (number of seconds since January 1, 1970)

* 'X' is replaced by the sensor or register number.

6.1.2 XML Control

Commands can be sent to the WebRelay Wireless to control the relays, counters, and registers.

Relay State Control

Commands are sent using a variable called relay1State. A few examples of using relay1State are given here.

Command	Description
state.xml?relay1State=0	Turn Relay 1 <i>OFF</i>
state.xml?relay1State=1	Turn Relay 1 <i>ON</i>

Pulse Relay

When the pulse command is sent, the output will turn *ON* for the Pulse Duration specified in the *Relay* setup page. It is also possible to send a pulse time command that is different than the configured Pulse Duration. This is done by sending a pulseTime1 variable. The pulseTime1 variable does not change the Pulse Duration in the setup page and it is not stored or recorded. The pulseTime1 variable only changes the duration for the single pulse initiated by that command. In other words, you must issue the pulseTime1 command for each pulse command that differs from the preset value.

For example, if the WebRelay Wireless is configured for a Pulse Duration of 1.5 seconds. To issue one 1.5 second pulse and one 5 second pulse you would issue the following commands.

Command	Description
state.xml?relay1State=2	Pulse Relay 1 for the preset time (1.5 seconds).
state.xml?relay1State=2&pulseTime1=5	Pulse Relay 1 for 5 seconds.

XML Set Counter

The counter value can be set using the count1 command.

Command	Description
state.xml?count1=200	Set counter1 to 200.

6.1.3 Message Acknowledgment

By default, when commands are sent to the WebRelay Wireless, the state.xml page is returned. The xml reply can be disabled by adding the `noReply` field as follows:

Command	Description
<code>state.xml?relay1State=1&noReply=1</code>	Turn Relay 1 <i>ON</i> without returning state
<code>state.xml?relay1State=0&noReply=1</code>	Turn Relay 1 <i>OFF</i> without returning state

6.2 HTTP GET Requests (for custom applications)

The WebRelay Wireless module has a built in web server that responds to HTTP GET requests. The server is always active. These GET requests are sent from web browsers when a web page is requested. They are fairly similar to the actual addresses seen in the browser's address bar. The following section describes the HTTP GET protocol and how it can be used to control and monitor the module.

6.2.1 Using GET for Control and Monitoring

There are many libraries and methods for sending a HTTP request programmatically. For reference, an example of how to manually build the HTTP request to control a relay is shown below. Please note that `\r\n` is not needed in all instances. The `\r\n` string is used to represent the Carriage Return and Line Feed characters. Since not all methods of using a string can handle the actual CR LF characters, the `\r\n` is used in its place. For example, if you are using a programming language, you will likely use `\r\n`. If you are typing the command directly into a terminal program for testing, you will simply press enter once for each set of `\r\n`. If you are unsure, try using `\r\n` first and if that doesn't work, you may try using the enter key. In no case will you need to use the string `\\r\n`.

No Password

GET requests to the device for XML files.

Example request state.xml:

```
GET /state.xml HTTP/1.1\r\n\r\n
```

Example turn Relay1 On:

```
GET /state.xml?relay1State=1 HTTP/1.1\r\n\r\n
```

Password Enabled

If the Control Password is enabled on the WebRelay Wireless and the state.xml page is requested through a browser, the user will be prompted for a password. If the XML request is sent from an XML application, the html request will need to contain the password, encoded as Base64.

The following is an html request header without the password:

```
GET /state.xml?relay1State=1&noReply=1 HTTP/1.1\r\n\r\n
```

The following example adds the password:

```
GET /state.xml?relay1State=1&noReply=1 HTTP/1.1\r\nAuthorization: Basic bm9uZTp3ZWJyZWxheQ==\r\n\r\n
```

`bm9uZTp3ZWJyZWxheQ==` is the Base64 encoded version of the user "name:password,"
`none:webrelay`.

A utility is provided at <http://www.controlbyweb.com/encoder> to encode the password. Simply type the string `username:password` into the website and press 'Encode'.

cURL Example

The following is an html request without a password:

```
curl "http://192.168.1.2/state.xml?relay1State=1"
```

The following example adds the ability to supply a password

```
curl --basic -u none:webrelay "http://192.168.1.2/state.xml?relay1State=1"
```

6.3 External Server and Remote Services

Note: The following methods are supported by the WebRelay Wireless; however, Xytronix Research & Design, Inc. does not provide or support custom third-party applications, or external web servers.

6.3.1 Accessing the WebRelay Wireless with custom software or third party applications

Custom applications can send commands to the WebRelay Wireless for monitoring and control functions using XML. (See XML for more information.) The application interface can be used to provide a custom user interface, access to multiple units in a single screen, and allow for automation, logging, and other application-specific features.

6.3.2 Using an External Web Server

Rather than accessing the WebRelay Wireless directly from a computer, an external web server can be used. The term “external” web server is used here to mean a separate web server (such as Apache or IIS) that is not the web server built into the WebRelay Wireless module. In this scenario, users access custom web pages that reside on the external web server and the external web server communicates with the module.

An external web server can integrate multiple ControlByWeb products into a single control page. In other words, the user may not be aware that he/she is using multiple ControlByWeb™ devices, but rather the user sees an integrated control page for the entire system. In addition, the use of an external web server allows programmers to create custom user interfaces that take advantage of the additional resources typically available on larger web servers, including more memory and various web programming languages.

There are two approaches that an external server can use to communicate with the WebRelay Wireless module and other ControlByWeb™ modules, *Direct Server Control* and *Remote Services*.

6.3.3 Direct Server Control

The first approach is for the external server to create a TCP connection whenever it needs to access the WebRelay Wireless. In this case, the external server opens the connection, sends commands and/or reads the device, and closes the connection.

This method is ideal when the web server and all of the WebRelay Wireless modules are on the same network (without routers between them). In this case, the server can communicate with the WebRelay Wireless modules directly and securely since data never has to leave the local network.

When the server and the WebRelay Wireless are on different networks, routers must be configured to allow appropriate access. If a public network is used, such as the Internet, security precautions should be considered.

6.3.4 Remote Services

The second approach is for the WebRelay Wireless to initiate a connection using the *Remote Services*. The settings under the WiFi *Network* tab in the setup pages will enable the WebRelay Wireless to open a TCP connection with an external server. Once the connection is open, the external server can send commands and/or read the device. The external server can leave the connection open (so that it never closes) or close the connection.

Remote Services is ideal for installations where the server and the WebRelay Wireless module are installed on different networks. This is especially useful when each module is installed on a separate private network. For example, if the user doesn't control the network connections where the WebRelay

Wireless module is installed, *Remote Services* would initiate a TCP connection over the Internet with the control computer. Since the WebRelay Wireless initiates the connection, the control computer doesn't have to know the IP address of the WebRelay Wireless module. This means that the module can be installed using DHCP. In addition, no special router configuration is required. This makes the network installation of WebRelay Wireless very simple, and since no incoming ports need to be opened in the router, security is not compromised. See WiFi Networks Tab for more information.

The WebRelay Wireless can be configured to establish a connection when triggered by an event, such as a I/O state changing. This is done by setting the *Remote Service* checkbox in the I/O setup tabs.

When an event occurs and a connection is open, the state.xml file is sent.

If a connection is not open and *Remote Services* is enabled, a connection will be established by sending the connection string. Once the connection is established state.xml will be sent.

In version 2.0 of the protocol, it is required for the server to send back an acknowledgment packet after every connection string message received. The server does this by sending a 3 byte packet back containing the string 'ACK'. Additionally, version 2.0 of the protocol introduces the use of SSL client certificates for authentication and encryption.

6.3.5 Connection String

With *Remote Services* enabled, a connection attempt will be made periodically according to the Connection Interval setting in the *Advanced Network* setup tab. The Connection String is a user-defined character string configured in the *Advanced Network* tab.

The connection string is also sent at the same interval once the connection is open. The external server is responsible for closing the connection when it is done.

In version 2.0 of the protocol, each connection string is prepended with the connection string type, MAC address, model number code and connection interval.

6.4 Email Notification

6.4.1 Email Notification Description

The WebRelay Wireless can be configured to send messages to up to eight email addresses when certain events occur. Events that can trigger email messages include relay/input state changes and temperature/humidity changes.

When an email message is sent, it looks similar to this:

```
XW-210

Trigger: Relay 1 ON

Relay 1: ON
Input 1: OFF
Count 1: 5.00
Sensor 1: 76.2° F
Sensor 2: 73.7° F
Sensor 3: 32.0° F
Sensor 4: 84.5° F
```

Note: Relays, Inputs, and Sensor names as well as ON and OFF status text may be customized by the user (installer) in the setup pages. The same field names are used on the Control Page.

Subject Line

The top line (that reads XW-210), appears in the subject line of the email message. This is the same text that appears as the header on the *Control Page*. It is set in the *Main Header* text field under the *Control Page Setup* tab.

Trigger

The first line displayed in the body of the message shows the event that triggered the message. The text "Trigger" will always appear and cannot be changed. The remaining text includes the trigger name, and what caused the trigger. The text that describes the trigger and its current state are configured in the setup pages as described below.

Current Status of the Digital Inputs, Relays, and Sensors

The remainder of the email message will display the same information shown on the *Control Page*. If the Short Message option has been selected, only the I/O that triggered the email will be shown.

6.4.2 Email Notification Setup

Email notification requires that the following fields are properly configured. See WiFi Networks Tab for a description of each field.

WiFi Networks Tab

IP Address
Subnet Mask
Gateway
Preferred DNS Server (this is required if Mail Server is entered by name and not by IP address)

SMTP Server
SMTP Server Port
User Name (If Required)
Password (If Required)
Return Email
Email 1
Email 2
Email 3
Email 4
Email 5
Email 6
Email 7
Email 8

Note: The WebRelay Wireless must be power-cycled (power disconnected, then reconnected) or rebooted before network settings take effect. Only the settings on the WiFi Network tab require power-cycling before taking effect.

Email triggers can be explicitly defined for each relay, input, and sensor under the *Relay*, *Input* and *Sensors* tabs.

The email options and recipients for each relay, input, and sensor are configured separately. Select the *Email Option* and the check box for the desired email recipient for each relay, input, and sensor.

Once the email settings are entered, the email functionality can be tested by clicking the 'Test Email' button. This will cause an email message to be sent immediately.

6.5 LogFile

The WebRelay Wireless logs information to log.txt. This log file is a text file stored in nonvolatile memory and will not be lost due to power failure. The log files are stored in a circular buffer which writes from the beginning of the allocated memory space to the end and then repeats from the beginning (over-writing the original data). The nonvolatile memory is divided into 4-Kbyte sectors. Each time data gets erased to make room for new data, a full sector (4-Kbytes) is erased at one time.

6.5.1 Data Log File – log.txt

This log file is user-configurable under the *Logging setup tab*, and stores real-world data such as temperatures and events such as relay state changes (see Logging Tab for more information). It can be up to 512-Kbytes long and is stored using a comma separated value formatting scheme.

Inputs, Relays, Vin, and Sensors will only be displayed if they are selected in the *Logging setup tab*. The file is read by requesting the log.txt file from the WebRelay Wireless. For example, using the default IP address the following command would be used to request the log file:

```
http://192.168.1.2/log.txt
```

File Format:

```
MM/DD/YYYY HH:MM:SS, Sensors 1-4, Relay 1, Input 1, Counter, Vin
```

Date and Time Format:

MM – Month (1-12)
DD – Day (1-31)
YYYY – Year (1970 - 2106)
HH – Hour in 24 hour time (0 -23)
MM – Minutes (0-59)
SS – Seconds (0-59)

Accessing the Log File

If the TCP port has been changed (not port 80), the port will be required to read the file. For example, using the default IP address, and port 8000, the log file would be read as follows:

```
http://192.168.1.2:8000/log.txt
```

Note: If the Control Password is enabled in the setup pages, the password will be required to access the log file.

The file can be saved using the 'Save As...' option under the 'File' menu of the web browser.

The log.txt file may then be erased with the following command:

```
http://192.168.1.2/log.txt?erase=1
```

Sample Log File

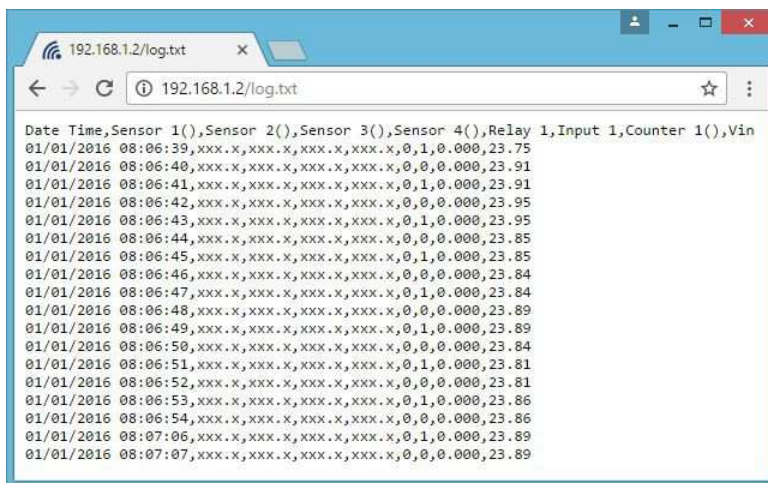

6.6 Modbus/TCP

The WebRelay Wireless module can be controlled and monitored using Modbus/TCP protocol. This provides a standard means of using the module with devices and software from other manufacturers. This section is not a tutorial on Modbus and it is assumed that the reader is already familiar with Modbus. Detailed Modbus information can be found at <http://www.modbus.org>.

Note: Modbus communications are disabled whenever the Control Password is enabled. This is because Modbus/TCP does not provide a mechanism for password protection. Make sure the Control Password is disabled (default) and Modbus functionality is enabled on the Advanced Network.

The WebRelay Wireless module functions as a Modbus slave. Host devices, such as PLCs, open a connection with the WebRelay Wireless on port 502 (configurable under *Advanced Network* tab) and then send requests to read or set relay states, read input states, or sensor values. When the WebRelay Wireless receives a command, it will perform the desired function and return a response.

The following sections provide an overview and explanation of Modbus operation.

6.6.1 WebRelay Wireless Modbus Function Code Summary

WebRelay supports the following function codes:

Code Name	Modbus Function	WebRelay Wireless Feature	WebRelay Wireless Start Address	
			Hexadecimal	Decimal
Read Coils	01	Relay 1	0x0000	0
Read Discrete Inputs	02	Input 1	0x0000	0
Read Analog Inputs	03	Vin	0x0010	16
Read Sensors	03	Sensors 1-4	0x0110-0x0116	272-278
Read Counters	03	Counter 1	0x0210	528
Write Single Coil	05	Relay 1	0x0000	0
Write Multiple Coils	15	Relay 1	0x0000	0
Pulse Coils	16	Relay 1	0x0310-0x0311	784-785

Multiple commands may be sent without closing and re-opening the connection, but if no data is transferred for 50 seconds, the connection will time out and close. To keep the connection open, a read request can be sent periodically.

The WebRelay Wireless has two TCP sockets available for Modbus/TCP. This allows two connections to be open at one time. Requests for more than two open connections will be rejected.

When errors occur, an error code is returned. Most Modbus client software will interpret this code in a human readable form. The code is comprised of the original function code plus 0x80. For example, an error during the read coils function 0x01 would return 0x81. Each error has a qualifying exception number. The following are the possible exception codes and their meanings:

- 0x01 - Function code not supported (also when Modbus is disabled in the setup pages).
- 0x02 - Incorrect starting address/quantity of output combination.

6.6.2 PLC Device Addressing

There are generally two schemes for accessing Modbus devices. The first is by specifying the Modbus function code, memory type, and address. The second, sometimes called PLC addressing, requires only the address.

Modbus protocol uses four different address ranges for discrete inputs, coils, input registers, and holding registers. The function code determines the address range of the message. The following are common function codes and their respective address ranges.

Code Name	Modbus Function	Data Type*	PLC Address Mode 485	PLC Address Mode 584/984
Coils (Read/Write)	01, 05, 15	Discrete	1-1000	1-10000
Discrete Inputs (Read only)	02	Discrete	1001-2000	10001-20000
Registers (Read only)	04	8-64 bits	3001-4000	30001-40000
Holding Registers (Read/Write)	03, 06, 16	8-64 bits	4001-5000	40001-50000

* Data types may be implemented at the discretion of the manufacturer. Address ranges may also overlap. Discrete is a binary or boolean value, 1 or 0.

Function codes, memory types, and addresses can be converted to the PLC addressing equivalent using the table below. To use the table, look up the row corresponding to the Modbus function code. Then take the desired WebRelay feature address and add to it the address offset in the PLC address mode column.

$$\text{Input Address} + \text{PLC Base Address} = \text{PLC Address}$$

For example, to read discrete Input 2

Input Address	1
PLC Base address	1001
PLC Address	1002

Programming the PLC to read from 1002 will return the value of Input 2.

Code Name	Modbus Function	WebRelay Wireless Addresses	Data Type	PLC Address Mode 485	PLC Address Mode 584/984
Read Coils	01	0 (Relay 1)	Discrete	Addr + 1	Addr + 1
Read Discrete Inputs	02	0 (Input 1)	Discrete	Addr + 1001	Addr + 10001
Read Holding Registers	03	16 (Vin)	32-bit float	Addr + 4001	Addr + 40001
		272-278 (Sensors 1-4)	32-bit float	Addr + 4001	Addr + 40001
		528 (Counter 1)	32-bit float	Addr + 4001	Addr + 40001
Write Coils	05	0 (Relay 1)	Discrete	Addr + 1	Addr + 1
Write Multiple Coils	15	0 (Relay 1)	Discrete	Addr + 1	Addr + 1
Write Multiple Registers	16	784-785 (Relay 1)	32-bit float	Addr + 4001	Addr + 40001

For 32-bit numbers or floats, two registers must be read starting at the desired address, examples of each are given for the applicable functions.

6.6.3 WebRelay Wireless Full Address Table

The table below gives commonly used function codes, memory types, data sizes, and equivalent PLC addresses for accessing the WebRelay Wireless. The data size will be the same regardless of the addressing mode.

	Function Code	Address (Decimal)	Data Size	PLC Address Mode 485	PLC Address Mode 584/984
Read Relay 1	01	0	Discrete	1	1
Write Relay 1	05	0	Discrete	1	1
Read Input 1 State	02	0	Discrete	1001	10001
Read Vin	03	16	32-bit Float	4017	40017
Read Sensor 1	03	272	32-bit Float	4273	40273
Read Sensor 2	03	274	32-bit Float	4275	40275
Read Sensor 3	03	276	32-bit Float	4277	40277
Read Sensor 4	03	278	32-bit Float	4279	40279
Read Counter 1	03	528	32-bit int	4529	40529
Write Multiple Relays	15	0	8-bit	1	1
Pulse Relay	16	784	32-bit Float	4785	40785

6.6.4 Read Coils - Modbus Function Code 01 (0x01)

Read the state of the relay.

Request

Start Address: 0x0000 (coil 1)

Coil Quantity: 0x0001 (1 coil)

Response

The WebRelay Wireless will respond to the request with a data field of one byte, each bit representing the coil status. A '1' indicates the Output is **ON**. A '0' indicates that the Output is **OFF**.

Bit zero of the return value will be the state of the coil corresponding to the start address. For example, if a start address of 0x0000 is used, bit zero will be the status of Relay 1.

Coil State Byte							
Bit 7	6	5	4	3	2	1	Bit 0
X	X	X	X	X	X	X	Relay 1

Errors

The sum of the start address and coil count cannot exceed the maximum coil count or an error response will be returned.

The following are possible error responses:

Coil Read Error Function Code (1 byte): 0x81

Exception Codes (1 byte): 0x01 – Function code not supported.

0x02 – Incorrect combination of start address and quantity of Relays

6.6.5 Read Discrete Inputs – Modbus Function Code 02 (0x02)

This function returns the state of the digital input.

Request

Start Address: 0x0000 (input1)

Input Quantity: 0x0001

The sum of the starting address and the quantity of coils must not be greater than 0x0001.

Response

The input state is indicated by bit zero of the status byte. A 1 indicates that the input is switched high *ON*. A 0 indicates that the input switched low *OFF*. Bit zero of the return value will be the state of the coil corresponding to the start address. For example, if a start address of 0x0000 is used, bit zero will be the status of input 1.

Discrete Input State Byte							
Bit 7	6	5	4	3	2	1	Bit 0
X	X	X	X	X	X	X	Input 1

Errors

Input Read Error Function Code (1 Byte): 0x82

Exception codes (1 Byte):
 0x01 – Function not supported.
 0x02 – Incorrect combination of start address and input quantity.

6.6.6 Read Sensors – Modbus Function Code 03 (0x03)

The Read Holding Registers function is used for the temperature and other Xytronix 1-Wire sensors.

Request

32-bit sensor values are read from 16-bit register pairs. Consequently, sensors addresses and registers must be even numbers.

Vin Start Addresses

Start Address: 0x0010 (Vin)
Input Quantity: 0x0002

Temperature and Other Sensor Start Addresses

Start Address: 0x0110 (Sensor Input 1) to 0x0116 (Sensor Input 4)
Input Quantity: 0x0002 to 0x0008

Counter Start Addresses

Start Address: 0x0210 (Count 1)
Input Quantity: 0x0002

Response

32-bit floating-point values are returned, either as little-endian or big-endian numbers, depending on the configuration in the **Advanced Network** tab.

With little-endian ordering, a temperature reading of sensor 1 (0x0110) would return 0x800042A2. The least significant word would be 8000 hex and the most significant word would be 42A2. This hexadecimal value converts to a temperature reading of 81.25 degrees.

If a temperature or other sensor is not installed, a value of 0xFFFFFFFF (NaN) is returned. Other inputs will show measured values of the open circuits.

Errors

Sensor Read Error Function Code (1 byte): 0x83

Exception Codes (1 byte): 0x01 – Function not supported.
 0x02 – Incorrect combination of start address and input quantity

6.6.7 Write Single Coil – Modbus Function Code 05 (0x05)

Relays may be controlled one at a time.

Request

Start Address (2 bytes): 0x0000 (Relay 1)
Output Value (1 byte): 0x00 (OFF), 0xFF (ON)
Padding (1 byte): 0x00

Response

The response mirrors the requested state, 0x00 or 0xFF.

Errors

Single Coil Write Error Function Code (1 Byte): 0x85
Exception codes (1 Byte):
0x01 – Function not supported.
0x02 – Address out of range.
0x03 – Padding value.

6.6.8 Write Multiple Coils - Modbus Function Code 15 (0x0F)

One byte can be written to set the state of all relays, each bit representing one relay.

Request

Relay states are controlled by specifying the start address of the first relay to be controlled, the count of the relays to be affected, and the relay state byte.

A relay value of 0xFFFF would be used to turn *ON* all of the relays in the range or 0x0000 to turn them *OFF*. In the above example, the relay value 0xFF would turn relay 1 *ON*.

Start Address (2 bytes): 0x0000 (Relays 1)
 Output Quantity (2 bytes): 0x0001
 Byte Count (1-2 bytes): 0x01
 Relay Value (1 bytes): 0x0000 – 0x0001

Relay State Byte							
Bit 7	6	5	4	3	2	1	Bit 0
X	X	X	X	X	X	X	Relay 1

Response

The quantity value is returned.

Errors

Multiple Coil Write Error Function Code (1 Byte): 0x8F
 Exception codes (1 Byte): 0x01 – Function not supported.
 0x02 – Incorrect combination of start address and Relay quantity
 0x03 – Byte count out of range.

6.6.9 Write Multiple Registers – Modbus Function Code 16 (0x10)

The Modbus Write Multiple Registers function can be used to pulse the relays.

Request

The Modbus Write Multiple Registers function is used to pulse the relay(s) for a specified time. When the WebRelay Wireless receives this command, it immediately turns the appropriate relay(s) *ON* (if not already on) and starts the pulse timer.

The pulse time is specified using floating point format in the register value field and can range from 0.1 seconds to 86400 seconds (1 day). When the pulse time expires, the relay will be turned *OFF*. If a pulse time command is sent with a value greater than 86400, the pulse timer will be set to 86400. If a pulse time command is sent with a value less than 0.1, the pulse timer will be set to 0.1.

If any commands are sent to the WebRelay Wireless (Modbus, XML or HTML) before the pulse timer has expired, the pulse timer will be canceled immediately and the new command will be executed.

IEEE 754 floating point format is used for the pulse time. The WebRelay Wireless may be configured for little-endian or big-endian transmission. The endian-ness is configured in the Modbus/TCP *settings*. (See WiFi Networks Tab for more information.)

Start Address (2 bytes):	0x0310 (relay 1)
Register Quantity (2 bytes):	0x0002
Byte Count (1 byte):	0x04
Pulse Duration (4 bytes/relay):	0x3DCCCCC – 0x47A8C000 (big-endian) 0xCCCC3DCC – 0xC00047A8 (little-endian)

Response

The request is acknowledged by responding with the register quantity that was requested.

Errors

Pulse Function code Error (1 Byte):	0x90
Exception codes (1 Byte):	0x01 – Feature not supported. 0x02 – Address quantity not an even number. Incorrect combination of start address and relay count.

6.7 Basic Scripts

BASIC (Beginners All-purpose Symbolic Instruction Code) is a computer programming language that has been in use for many years. The WebRelay Wireless has an integrated BASIC interpreter for a simple BASIC script. This provides a great deal of flexibility by allowing users to customize basic functions of the unit. The interpreter only supports a small subset of the BASIC commands that are available for larger computers. Some non-standard commands have been added, and some commands may function differently on the WebRelay Wireless BASIC interpreter than on other platforms. The following is a short tutorial on the supported BASIC functions.

Example scripts are available at https://www.controlbyweb.com/support/sample_code.html. Contact customer support if further assistance is required.

6.7.1 Structure

A BASIC script is written as a .txt file, which is then uploaded to the device using the *Script* setup tab. The maximum script size is 4-Kbytes. Each line within the script contains a single statement. Line numbers are not used.

Statements are not case sensitive; however, variables are.

IF THEN, FOR loops, and DO loops can only be nested up to 5 times per command. For those not familiar with nesting, the following is an example of nested FOR loops:

```
FOR a = 0 to 100
  FOR b = 0 to 100
    NEXT b
  NEXT a
```

Every program must end with an END statement. Subroutines would then follow after the END statement, if required. The last line of the script should be left blank.

6.7.2 Line Format

Every line follows the same format. The basic format is:

statement (variable) (=, <, >, <=, >=, <>) (expression) (THEN)

The fields in parentheses are optional depending on the statement. Spaces must be used between all statements, numbers, variables, operators, expressions, etc. Multiple spaces are invalid.

Comments may be inserted, but must begin with an apostrophe and remain on the same line.

Examples:

```
LET a=1           'this will return an error because of insufficient spacing
LET a = 1         'this is valid
LET a = 1         'this will return an error because of too many spaces
```

Only a single variable or literal is allowed on the left side of any operator. The following example is incorrect and will return an error. The error occurs because there is more than a single value to the left of the comparison operator (a + 2 is to the left of =).

```
IF a + 2 = 3 THEN 'this will return an error
```

To fix the above line, replace 'a + 2'. One of the following options may be used:

```
LET b = a + 2
IF b = 3 THEN
...
END IF
```

6.7.3 Supported Statements

The following are the statements supported by the ControlByWeb™ BASIC interpreter.

LET

The LET statement assigns a variable a value. The format is:

```
LET (variable) = (expression)
```

IF THEN, ELSE, END IF

The IF THEN statement tests the truth of a condition. The ELSE statement defines a second function if the condition is found false. In other words, if the condition is true, then a function is performed. If it is not true, a second function may be performed. The second function may or may not be necessary depending on the application. The IF THEN (ELSE) statement must always be followed with an END IF statement. The format is:

```
IF (variable) (=, <, >, <=, >=, <>) (expression) THEN  
  (Function 1)  
ELSE  
  (Function 2)  
END IF
```

Note: In most BASIC interpreters, 'Function 1' (see above) may be placed after the THEN statement. This interpreter requires 'Function 1' to be put on the following line.

FOR TO, NEXT

The FOR TO statement loops a section of code a predefined number of times. The NEXT statement always follows the section of code to be looped. The format is:

```
FOR (variable) = (expression) TO (expression)  
  (code to be looped)  
NEXT (variable)
```

DO WHILE, LOOP

The DO WHILE statement loops a section of code while a condition is found true. The LOOP statement always follows the section of code to be looped. Note that if the condition is omitted, the code will be looped without end. The format is:

```
DO WHILE (variable) (=, <, >, <=, >=, <>) (expression)  
  (code to be looped)  
LOOP
```

Example:

```
let t0 = 100  
do while t0 > 0  
  ' wait  
loop
```

LOG

The LOG statement causes the device to log data according to the settings specified under the *Logging setup tab*.

Note: In order to log, logging must be enabled in the Logging setup tab.

The format is: LOG

EMAIL

The EMAIL statement causes the device to send an email of the same format as that generated by other status change and alarm conditions. The event that triggered the email is given, followed by the I/O or Sensor that you want to email. The format is:

EMAIL (feature state – relay1, input1, tempX) 'X represents the feature number such as temp2

Examples:

```
EMAIL          'Status email sent to addresses listed under Network tab.
...or...
EMAIL relay1 'Sends state change message to emails setup in I/O tab.
...or...
EMAIL input1 'Input state change message to emails setup in I/O tab.
...or...
EMAIL temp2  'Temp alarm message sent to recipients in the Sensors tab.
```

END

The END statement ends the main body of code.

CALL

The CALL statement is found within the main body of code, but requires the interpreter to skip to a subroutine found at the end of the program. After the subroutine is finished, the interpreter returns to the line immediately following the CALL statement. The format is:

CALL (name of subroutine)

SUB, END SUB

The SUB statement defines the beginning and name of a subroutine. The END SUB statement defines the end of the respective subroutine. Subroutine names can be up to 20 characters long and are case sensitive. The SUB and END SUB statements always must follow the END statement. The format is:

```
END

*** Subroutines Go Here ***
SUB (name of subroutine)
  (contents of subroutine)
END SUB
SUB (name of subroutine)
  (contents of subroutine)
END SUB
```

REM or '

The REM or apostrophe (') statement designates remarks made by the programmer. The interpreter will disregard any characters on the line following these statements.

PRINT

The PRINT statement displays a variable or message to the display. The PRINT statement is only available for the PC version of the BASIC interpreter. The device will not recognize the command since it does not have an operator display. The format is:

```
PRINT (variable) 'show variable value to screen
PRINT "(message)" 'show '(message)' to screen
```

6.7.4 User-Defined Variables

Two types of variables are available for use in the ControlByWeb™ BASIC interpreter, user-defined variables, and predefined variables.

Up to 10 user variables may be initialized. These must be single character, lower case letters.

a, b, c, d, e, f, g, h, i, j

They are always global and stored internally as floating point numbers. Variables are defined using the LET statement.

Examples:

```
Let b = 5           'variable b will be set to 5
Let d = b + 2      'variable d will be set to 7
```

6.7.5 Predefined Variables

The following are useful predefined variables for the ControlByWeb™ BASIC interpreter. These are useful for accessing internal values and features states.

6.7.5.1 Timer Variables

Six timers are available for use in BASIC scripts.

t0, t1, t2, t3, t4, t5

Timers can be set to any positive integer (or 0) by using the LET statement. As soon as a value is assigned to a timer, it will begin to count down immediately by decrementing one count every 100 ms until it reaches zero.

Examples:

```
Let t3 = 1500      'set timer 3 to 150 seconds
Let t1 = 0         'disable time 1
```

6.7.5.2 Relay Variables

Relay variables represent the state of the relays and can be used to change the state of the relays. Remote relays can also be controlled, but not read. The following variables are available.

```
relay1           'relay 1
rmt_relay1       'remote relay 1
rmt_relay2
```

Note: Commands can be sent to remote relays, but the states of those relays cannot be read. Consequently, remote relays should not be used in safety or security-critical applications.

Relay outputs can be turned ON, turned OFF, pulsed, toggled, or read in BASIC scripts. The LET statement is used to set the output state. The state options available are:

```
0 – turn relay off
1 – turn relay on
2 – pulse relay
5 – toggle relay
```

The pulse time is specified in the **Relay** setup tab.

Examples:

```
Let relay1 = 1     'turn on relay 1
Let relay1 = 0     'turn off relay 1
Let relay1 = 2     'pulse relay 1
Let relay1 = 5     'toggle relay 1
```



```
Let a = relay2      'read the state of relay 2, state will be 0 or 1
```

6.7.5.3 Input Variables

The digital input states can be read in BASIC scripts.

```
input1      'digital input 1
```

Example:

```
Let a = input1    'sets 'a' equal to value of input 1
```

6.7.5.4 Counter Variables

The input counter can be read in BASIC scripts.

```
count1      'input 1 counter
```

Example:

```
If count1 > 5000 Then      'If input counter 1 is greater than 5000 then
    Let relay1 = 1        'turn output 1 on
End If
```

6.7.5.5 Vin Variable

The vin voltage can be read in BASIC scripts.

```
vin      'Read the Vin voltage
```

Example:

```
If vin > 10 Then          'If Vin is greater than 10 volts then
    Let relay1 = 2        'Pulse output 1, otherwise
Else
    Let relay1 = 0        'output1 will be off
End If
```

6.7.5.6 Temperature/Other Sensor Variables

Each temperature sensor or other Xytronix 1-Wire sensor can be read in BASIC scripts.

```
temp1      'temp or other sensor 1
temp2      'temp or other sensor 2
...
temp4      'temp or other sensor 4
```

Example:

```
If temp2 >= 80 Then      'If temperature sensor reads greater than 80
                        ' degrees, then
    Let relay2 = 1        'Turn on relay 2
End If
```

6.7.5.7 Date and Time Variables

The variables 'time' and 'date' are predefined, read only variables that store the current date and time. They can be used to schedule events and activities, such as sending emails, reading temperature, or setting Outputs. The date uses the mm/dd/yyyy format. Clock time is formatted as hh:mm:ss (24-hour clock).

Example:

```
If date = 01/01/2014 Then
    If time > 12:30:00 Then
        Let relay2 = 1
        Let relay3 = 0
    End If
End If
```

*Note: Current date and time can only be set in the **Date/Time** tab.*

6.7.5.8 Event Variables

Data and time variables can be used to execute script events.

Up to five date variables are available.

```
ed1      'event date variable 1
...      'ed2, ed3, ed4
ed5      'event date variable 5
```

The value assigned to event variables should be in the format mm/dd/yyyy. The event date variables store the number of days that have passed since January 1, 1970.

Event time variables may be used in math expressions as well as comparison statements.

Time variables have a similar naming convention.

```
et1      'event time variable 1
...      ' et2, et3, et4
et5      'event time variable 5
```

Event time variables are declared in the format hh:mm:ss in 24-hour time. The event time variables store the number of seconds from the beginning of the day.

Event date and event time variables of the same number are linked. If the event time variable is incremented more than the number of seconds in a day (86400 seconds), the variable is reset to 0 and the event date variable is incremented by one. For example, if et3 rolls over to zero, ed3 will be incremented.

The following script example demonstrates defining the event variables and comparing it to the current date and time. Assume current time is April 10, 2010 at 1:30 AM and the event should occur in one hour and every hour thereafter.

Example:

```
Let a = 1
Let ed1 = 04/10/2010      'sets the event date to April 10,
                          '2010.
Let et1 = 02:30:00      'sets the event time to 2:30
Do While a <> 0
  If ed1 >= date Then    'Tests event date versus current date.
    If et1 >= time Then  'Tests event time versus current time.
      Let et1 = et1 + 3600 'Increments the event time by one hour
                          '(in seconds).
      Print "Event"      'Event to occur
    End If
  End If
Loop
End
```

6.7.6 Registers

Registers are similar to general purpose variables and can be used in the same manner. The difference between general purpose variables and registers is that external registers can be accessed by the user through a web browser and modified while the script is running. Scripts can use registers as a method of retrieving user input.

```
register1 'register variable 1
...      'register2, register3
register4 'register variable 4
```

The following example demonstrates this by creating a script that will turn Remote Relay 1 *ON* if register1 equals 1 and *OFF* otherwise.

Example:

```
Do
  If register1 = 1 Then
    Let rmt_relay1 = 1
  Else
    Let rmt_relay1 = 0
  End If
  Call delay
Loop
End

SUB delay
  Let t1 = 10
  Do While t1 > 0
    Loop
  End Sub
```

Registers can also be used to show numeric values, such as a count down timer. If the register is any other value than 1 or 0, the value will be displayed in the Status 2 column. See *Control Page* and *Register Setup Tab* for instructions on configuring Registers for visibility on the *Control Page*.

The following code will show a count down from 10 seconds and automatically restart. The refresh rate for the control page is set to 3 seconds, so the countdown may appear to jump.

Example:

```
let t0 = 10                                'Initialize variables and start timer
let register1 = 10

'Main Loop
Do
  if t0 = 0                                'when timer reaches 0 decrement counter
    let register1 = register1 - 1
    let t0 = 10
  end if

  if register1 < 0                          'restart when counter reaches zero
    let register1 = 10
  end if

loop
end
```

register1 can be set and cleared by entering the following requests into a web browser or by configuring on and off buttons to appear on the *Control Page* for register1:

```
http://192.168.1.2/state.xml?register1=1
http://192.168.1.2/state.xml?register1=0
```

6.7.7 Testing and Debugging

A copy of the BASIC interpreter for Windows is available on <https://www.controlbyweb.com/support/utilities.html> for testing and debugging. The WebRelay Wireless will only acknowledge errors as it runs. This means that if a path of the script is not encountered, errors may still exist. The Windows version of the interpreter will still check for errors before the script is run.

The PRINT function is available for use with the Windows version of the BASIC interpreter. The interpreter on the device, however, will not recognize this command.

Note: The script will be restarted by submitting any of the setup pages or by power cycling the unit.

The "MISSING END OF LINE" error may be caused by misspelled names or a program that is too long. 4096 bytes of memory is reserved for BASIC scripts. Each text character, space, punctuation mark, tab, or carriage return uses one byte. If the script is too long, the script will be truncated and will not function as desired.

Appendix A: Specifications

Wireless Specifications

Network Standards:	IEEE 802.11b/g/n
Frequency Band	2.412 – 2.462 GHz
Wi-Fi Security Standards	Open, WEP, WPA, WPA2
Network Settings:	DHCP or Static
Wireless Range	Up to 250ft (typical for Wi-Fi devices) depends on environment
RF Output Power (typ)	14dBm (802.11b/g), 12dBm (802.11n)
Antenna (included):	External, 2.4 GHz, 50Ω, omni directional, 1/4 wavelength, gain: ≤ 2.1dBi. With articulated reverse SMA connector.

Operation

Provisioning:	Via internal web server (no cables or PC utilities needed)
Access Point:	Yes, push button activated (setup via web page)
WPS:	Yes, push button activated (Wi-Fi Protected Setup)
Connectivity:	Always connected
Remote Server:	ControlByWeb's X-600™ or cloud-based server
Remote Relays:	Control relays on other ControlByWeb™ products
Polling:	state.xml (web-server is always active)

Power Requirements

Input Voltage:	9-28 VDC
Current:	See table below for typical values at 25°C

Test Conditions	9VDC	12VDC	24VDC
AP Mode <i>relay Off and input Off</i>	68mA	51mA	31mA
Attempting to connect to AP <i>relay Off and input Off</i>	68mA	52mA	36mA
Connected to AP with network traffic <i>relay Off and input Off</i>	65mA	50mA	28mA
Connected to AP with network traffic <i>relay On and input Off</i>	185mA	140mA	72mA
Connected to AP with network traffic <i>relay Off and input On</i>	75mA	57mA	31mA
Connected to AP with network traffic <i>relay On and input On</i>	188mA	143mA	75mA

Push Buttons

Button 1:	Force access-point mode
Button 2:	Activate WPS mode

Relay Contacts

Load Type:	General purpose
Contact Form:	SPDT (form C)
Contact Material:	Silver Nickel
Max Voltage:	277 VAC (general purpose)

	30 VDC (NC contact, resistive)
Max Current:	12A
Electrical Life:	100K cycles, typical @ full-rated load (higher with smaller load)
Mechanical Life:	10M cycles, typical
Control Options:	On/Off or Pulsed
Pulse Timer Duration:	100ms to 86400 Seconds (1-day)

Relay Connector Specifications

Type:	3-position, removable, 7.62 mm (.30") pitch
Connection wire:	Use wire rated for 95°C (min) for field wiring connections to the relay terminal block (MTW Machine Tool Wire rated for 105°C is recommended)
Stripping Length:	7mm
Connection capacity:	2.5mm ² stranded, 2.5mm ² solid
Conductor minimum:	30AWG (UL/CUL)
Conductor maximum:	12 AWG (UL/CUL)
Conductor Type:	Copper
Tightening torque:	0.5 Nm min, 0.6 Nm max, (5.0 lb-in)

Power Connector Specifications:

Type:	8-position, removable, 3.81 mm pitch
Connection wire:	Use wire rated for 75°C (min) for connections to the terminal block
Stripping Length:	7mm
Connection capacity:	1.5mm ² stranded, 1.5mm ² solid
Conductor minimum:	30AWG (UL/CUL)
Conductor maximum:	14 AWG (UL/CUL)
Conductor Type:	Copper
Tightening torque:	0.22 Nm min, 0.25 Nm max, (2-4 lb-in)

Digital Input

Number of Inputs:	1
Minimum Pulse Time (high or low):	25mS
Input Current (Iin):	950uA @ 4V, 8.5mA @ 26V
Isolation (Viso):	1,500 Vrms
Reverse voltage (Vr):	6V max
Vin:	26V (max)
Vin Hi:	4V (min)
Vin Lo:	1.5V (max)
Input counter:	32-bit floating-point

1-Wire Sensor Input

Maximum number of sensors:	4
+5Vout Output:	5.0V, 100mA max
Maximum cable length:	600 feet maximum cable length
Works with Maxim (Dallas) Semiconductor DS18B20 digital 1-Wire thermometer	
Works with X-DTHS-P (temperature/humidity), X-TC1W-K (thermocouple) and other supported digital "1-Wire" sensors	
Sensors are interchangeable, no calibration needed	

LED Indicators (4)

Green:	Power On
Yellow:	Relay On, Input On, Link

Configuration

Celsius/Fahrenheit:	User configurable
Temperature Reports:	Interval
Switch Status Reports:	Interval, on state change, or both
Report Rate:	User configurable

Email alerts

Email Alerts:	Configurable, up to 8-addresses
Encrypted Email Alerts:	Yes
Temperature Alerts:	High or low temperature
Input Status Alerts:	Input on, input off, or input change

Real-Time Clock

Manual or NTP (Network Time Protocol) setup, (not battery backed)
 NTP sync configurable for once, daily, weekly or on power-up
 Automatic daylight savings adjustment

Logging

Stored in non-volatile flash memory
 Circular buffer 512-Kbytes (16000 to 32512 log entries depending on configuration)

Scripts

Implement special or custom features with a BASIC script
 Max size 4-Kbytes

Environmental

Operating Temperature:	-40°C to 57°C (-40°F to 135°F)
Storage Temperature:	-40°C to 85°C (-40°F to 185°F)
Humidity:	5% to 95% non condensing
Altitude:	Up to 2000 meters
Environmental Rating:	Pollution Degree 2
Installation:	Must be installed inside an NRTL certified industrial control panel or similar NRTL certified fire/electrical enclosure

Mechanical

Size:	1.41 x 3.88 x 3.1 in. (35.7 x 98.5 x 78 mm), (not including connector)
Weight:	5.4 oz (154 g), (including connectors and antenna)

Electromagnetic Compliance

FCC ID: 2AE4Z-XWD002
 FCC 47CFR15 (Class B)
 IEC CISPR 22, CISPR 24
 EN55024 ITE Immunity (2010)
 EN55022 Emissions (2010)
 IC: 21441-XWD002
 EMC95120-ETSI328 (Australia)
 EMC95120-IEC62311 (Australia)

**Product Safety Compliance**

UL 61010-1 (Electrical Equipment for Measurement, Control, and Laboratory Use)

Appendix B: Trademark and Copyright Information

This document is Copyright ©2017 by Xytronix Research & Design, Inc. All rights reserved.

XW-210™, WebRelay Wireless™, WebRelay™, ControlByWeb™, and Xytronix Research & Design™ are trademarks of Xytronix Research & Design™, Inc. 2005-2017.

All other trademarks are the property of their respective owners.

All parts of this product and design including but not limited to firmware, hardware design, schematics, PCB layout, concept, graphics, users manual, etc., are property of Xytronix Research & Design, Inc. ©2005-2017. WebRelay Wireless™ may not be copied or reverse-engineered.

No part of this manual may be reproduced or transmitted in any form or by any means, electronic or mechanical, including photocopying or scanning, for any purpose other than the personal use by the purchaser of this product. Xytronix Research & Design, Inc., assumes no responsibility for any errors that may appear in this document.

Whereas reasonable effort has been made to make the information in this document as useful and accurate as possible, Xytronix Research & Design, Inc. assumes no responsibility for the application, usefulness, or completeness of the information contained herein. Under no circumstance will Xytronix Research & Design, Inc. be responsible or liable for any damages or losses including direct, indirect, special, incidental, or consequential damages or losses arising from either the use of any information contained within this manual or the use of any products or services referenced in this manual.

Xytronix Research & Design, Inc. reserves the right to change any product's features, specifications, documentation, warranties, fee schedules, and conditions at any time and without notice.

Appendix C: Warranty

This Xytronix Research & Design, Inc. product is warrantied against defects in material and workmanship for a period of five years from the date of shipment. During the warranty period, Xytronix Research & Design, Inc. will, at its option, either repair or replace products that prove to be defective. This warranty is extended to the original purchaser of the equipment only.

For warranty service or repair, customer must contact Xytronix Research & Design, Inc. technical support (support@ControlByWeb.com) and obtain a Return Authorization number (RA#). Before issuing an RA#, a support technician will work with customer to try to resolve the issue without returning the product. If technician determines that product must be returned for service an RA# will be issued. Next, the product must be properly packaged and returned to Xytronix Research & Design, Inc. with the RA# clearly marked on the package. The purchaser shall prepay all charges for shipping to Xytronix Research & Design, Inc. For warranty repairs of products less than one year old, Xytronix Research & Design, Inc. will pay the shipping charges to return the product to the purchaser as long as the product is shipped within the continental United States. If the product is shipped outside of the continental United States or the product was shipped more than one year earlier, the purchaser shall pay all shipping charges, duties, and taxes.

Limitation

The foregoing warranty shall not apply to defects or damage resulting from improper use or misuse, unauthorized repair, tampering, modification, improper connection, or operation outside the electrical/environmental specifications for the product. Further, the warranty does not cover Acts of God, such as fire, flood, hurricanes, and tornadoes. This warranty does not cover damage to property, equipment, direct, indirect, consequential, or incidental damage (including damage for loss of business profit, business interruption, loss of data, and the like) arising out of the use or misuse of this product.

UNDER NO CIRCUMSTANCES WILL THE LIABILITY OF XYTRONIX RESEARCH & DESIGN, INC. TO THE PURCHASER OR ANY OTHER PARTY EXCEED THE ORIGINAL PURCHASE PRICE OF THE PRODUCT, REGARDLESS OF THE FORM OF THE CLAIM. No other warranty is expressed or implied. Xytronix Research & Design, Inc. specifically disclaims the implied warranties or merchantability and fitness for a particular purpose. Some jurisdictions may not allow the exclusion of limitation of liability for consequential or incidental damage.

Appendix D: FCC Statement

This device complies with Part 15 of the FCC Rules. Operation is subject to the following two conditions:

1. This device may not cause harmful interference.
2. This device must accept any interference received, including interference that may cause undesired operation.

Warning

This equipment has been tested and found to comply with the limits for a Class B digital device, pursuant to part 15 of the FCC Rules. These limits are designed to provide reasonable protection against harmful interference in a residential installation. This equipment generates, uses and can radiate radio frequency energy and, if not in-stalled and used in accordance with the instructions, may cause harmful interference to radio communications. However, there is no guarantee that interference will not occur in a particular installation. If this equipment does cause harmful interference to radio or television reception, which can be determined by turning the equipment off and on, the user is encouraged to try to correct the interference by one or more of the following measures:

- Reorient or relocate the receiving antenna.
- Increase the separation between the equipment and receiver.
- Connect the equipment into a relay on a circuit different from where the receiver is connected.
- Consult the dealer or an experienced radio/TV technician for help.

Notice

Changes or modification not expressly approved by the party responsible for compliance could void the user's authority to operate the equipment.

RF Exposure Information

This equipment complies with the FCC RF radiation exposure limits set forth for an uncontrolled environment. The antennas used with this transmitter must be installed to provide a separation distance of at least 20cm from all persons and must not be located or operating in conjunction with any other antenna or transmitter.

Canadian License-Exempt Radio Apparatus (RSS-GEN)

This device complies with Industry Canada license-exempt RSS standard(s). Operation is subject to the following two conditions: (1) this device may not cause interference, and (2) this device must accept any interference, including interference that may cause undesired operation of the device.

Le présent appareil est conforme aux CNR d'Industrie Canada applicables aux appareils radio exempts de licence. L'exploitation est autorisée aux deux conditions suivantes : (1) l'appareil ne doit pas produire de brouillage, et (2) l'utilisateur de l'appareil doit accepter tout brouillage radioélectrique subi, même si le brouillage est susceptible d'en compromettre le fonctionnement.

Under Industry Canada regulations, this radio transmitter may only operate using an antenna of a type and maximum (or lesser) gain approved for the transmitter by Industry Canada. To reduce potential radio interference to other users, the antenna type and its gain should be so chosen that the equivalent isotropically radiated power (eirp) is not more than that necessary for successful communication.

Appendix E: Mechanical Dimensions

Note: A 3D-CAD model of the WebRelay Wireless is available at <https://www.controlbyweb.com/webrelay-wireless/downloads.html>

