

70M 9x9 Seamless 4K HDMI Matrix Extender 3x3 Video Wall 4K Processor

OPERATION MANUAL

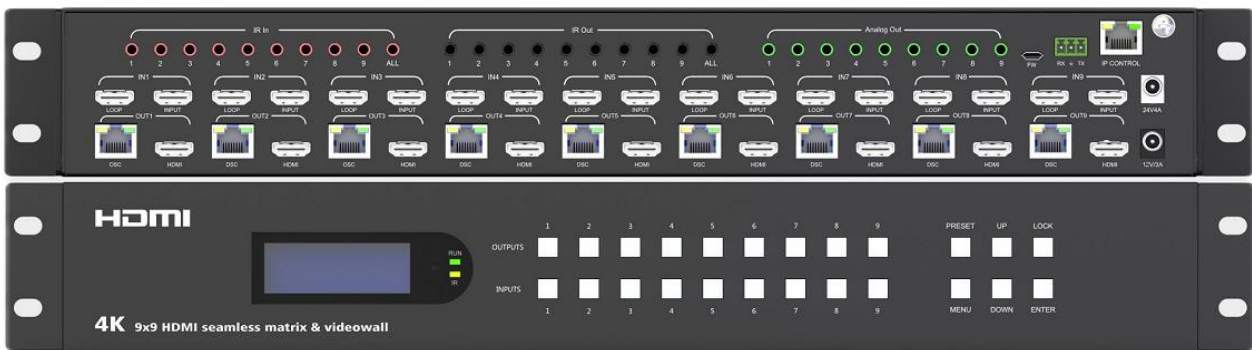

Thank you for purchasing this product. For optimum performance and safety, please read these instructions carefully before connecting, operating or adjusting this product. Please keep this manual for future reference.

SURGE PROTECTION DEVICE RECOMMENDED

This product contains sensitive electrical components that may be damaged by electrical spikes, surges, electric shock, lightning strikes, etc. Use of surge protection systems is highly recommended in order to protect and extend the life of your equipment.

Table of Content

目录

Dear Customer	4
1. Features	4
2. Package Contents	5
3. Specifications	5
4. Panel Descriptions.....	7
5. Video switching operation.....	9
5.1 Video Control	10
5.2 Mode Control	14
5.3 Audio Setting.....	17
5.3.1 OUT 1~9	17
5.3.2 ALL.....	17
Audio Interface	17
5.4 EDID Setting.....	18
5.5 Preset setting	18
5.6 Setup Section.....	19
5.7 Info Section	22
6. Remote Controller.....	23
7. WEB Control:	24
7.1 Non-networked control	24
7.2 LAN multiple simultaneous control.....	25
Account number: admin.....	25
Password: admin	25
LOGIN Interface.....	25
Video Output Interface.....	26
8. RS232 Control	32
9. IR System.....	34
10. Firmware updating	34
11. Application Diagram	37
MAINTENANCE	39
PRODUCT SERVICE.....	39
WARRANTY	39

Dear Customer

Thank you for purchasing this product. For optimum performance and safety, please read these instructions carefully before connecting, operating or adjusting this product. Please keep this manual for future reference.

1. Features

- 9xHDMI input, 9xHDMI loopout, 9xHDMI output and 9xDSC output(POC)
- Support resolution up to HDMI 1.4v 4K30Hz 4:4:4, deep color 12bit, bandwidth 10.2Gbps
- Support transmit upto 70m under 4k@30hz or 1080p@60hz by connecting with receiver
- Support video signal seamless switching; Video wall; Preset setting, etc
- Support Balanced Audio Extraction
- Support Panel Button, IR Remote, TCP/IP control, RS232 Commands control
- With Built-in EDID (4K30Hz, 1080P)
- HDCP 2.2/1.4 compliant
- Support Micro USB for firmware updating
- Video wall mode (Max 3x3) support adjust the screen edge
- Support cascade to create max 10×10 videowall, 180° rotation, and mirror function

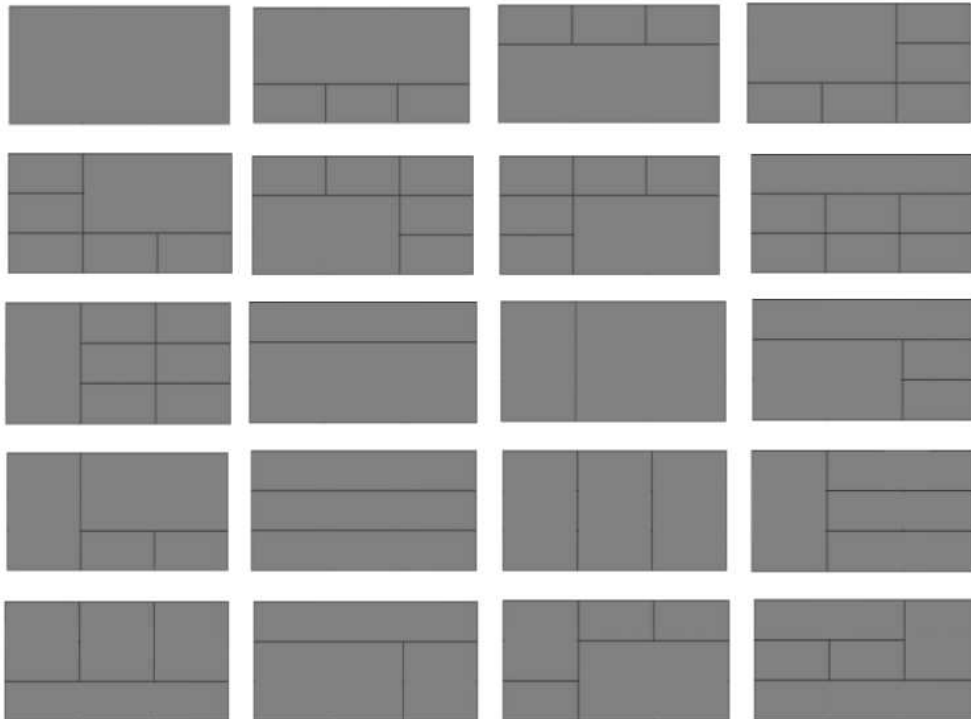

2. Package Contents

- ① Main Unit x1
- ② Power Adapter DC24V4A x1
- ③ Power Adapter DC12V3A x1
- ④ Remote Controller x1
- ⑤ Mounting ear kit x1
- ⑥ IR-TX& IR-RX cable kit x1
- ⑦ Disk (User manual; Update software; Command list) x1

3. Specifications

Operating Temperature Range	-5 to +40°C(23 to +104 °F)
Storage Temperature Range	-10 to +60°C(-14 to +140 °F)
Operating Humidity Range	5 to 90 % RH (no condensation)
HDMI Input	9 x HDMI In
HDMI Output	9 xHDMI loopout, 9 x HDMI Out
Audio output	Analog (Balanced audio)
Video Format Supported	4k@30Hz/1080P/720P/576P/480P/480i
HDCP Compliant	HDCP2.2 and HDCP1.4
Control way	Panel button/Remote/TCP/IP/RS232
Audio Format Supported	PCM, Dolby5.1/7.1, DTS5.1/7.1 digital audio
USB	Firmware update
Dimensions	1.5U Rack Design L489 x W336 x H67.5 mm
Mass (Main Unit)	5.48 KG

VESA Resolution List

Rate	Resolution	Supported	Mark
60Hz	640×480	√	
	800×600	√	
	1024×768	√	
	1280×768	√	
	1280×1024	√	
	1400×1050	√	
	1600×1200	√	
	1920×1080	√	
	1280×720	√	
	1360×768	√	
1920×1200	√		

Testing Resolution List

Rate	I/P	Resolution	Supported	Mark
50hz	P	576P	√	
	P	720P	√	
	P	1080P	√	
	P	4K2K	√	
60Hz /59.94Hz	I	480i	√	
	P	480P	√	
	P	720P	√	
	P	1080P	√	
	P	4K2K	√	
30/29.97Hz	P	720P	√	
	P	1080P	√	
	P	4K2K	√	
24Hz	P	720P	√	
	P	1080P	√	
	P	4K2K	√	
25Hz	P	720P	√	
	P	1080P	√	
	P	4K2K	√	

4. Panel Descriptions

FRONT:

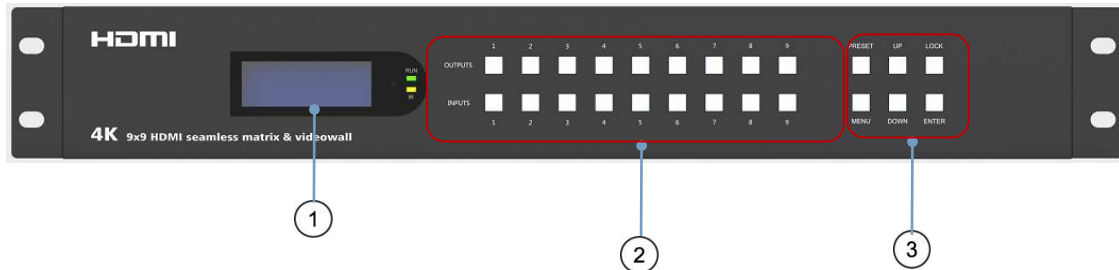

- ❶ LED Display
- ❷ OUT AND IN PUT 1~9 (When switching, press Output first, then press Input)
- ❸ Function button: PRESET; MENU; UP; DOWN; LOCK; ENTER

Channel	Button method
Output 1-9	Press the Output button to select the output, press again means cancel the selection; Long press means selecting all, again means cancel selecting
Input 1-9	After you press output button,then press the input button to select the input (only when selected the output, then input can be effected) Long press input to enter video wall mode
Menu	Function button: back to the last menu, long press can back to main menu
ENTER	Function button: Enter menu
UP	UP
DOWN	DOWN
PRESET	Select the preset mode(save,read,clear), long press to save the preset
LOCK	Long press(3s): LOCK the button; long press again to UNLOCK

REAR:

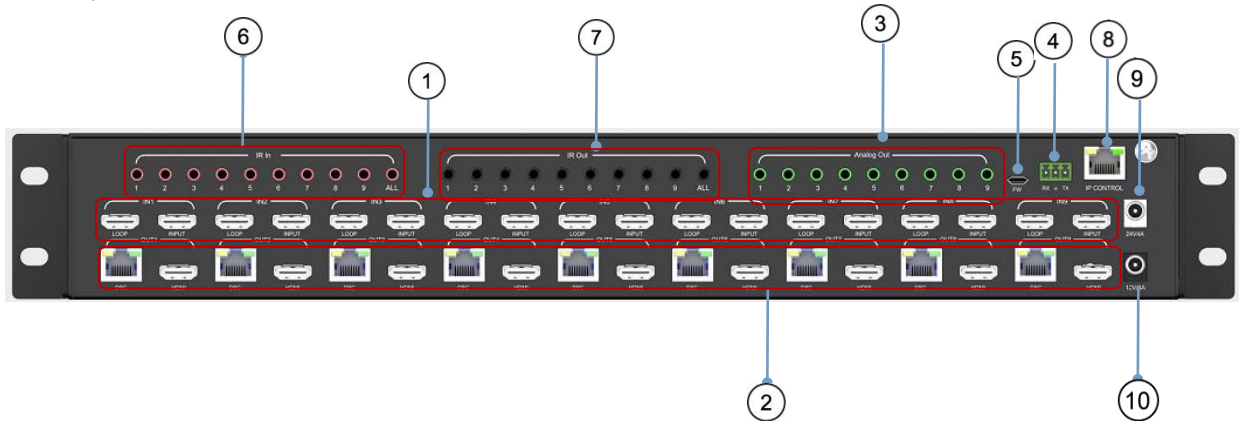

- ① HDMI Input port & Loopout port
- ② HDMI out port & DSC output port
- ③ Balanced Analog Audio Out port
- ④ RS232 interface: Commands control/RS232 pass through
- ⑤ FW interface: used for firmware upgrade
- ⑥ IR In: IR in port
- ⑦ IR Out: IR out port
- ⑧ ETHERNET port (TCP/IP): Control the product
- ⑨ DC input interface(24V4A): DC power input, external power adapter
- ⑩ DC input interface(12V3A): DC power input, external power adapter

5. Video switching operation

The signal switch includes 9 switching channels, which can be configured as input/output according to the requirements, forming a matrix of 1 x 9 ~ 9 x 1, which can switch any input signal to 1 output or all output.

The specific operation is as follows:

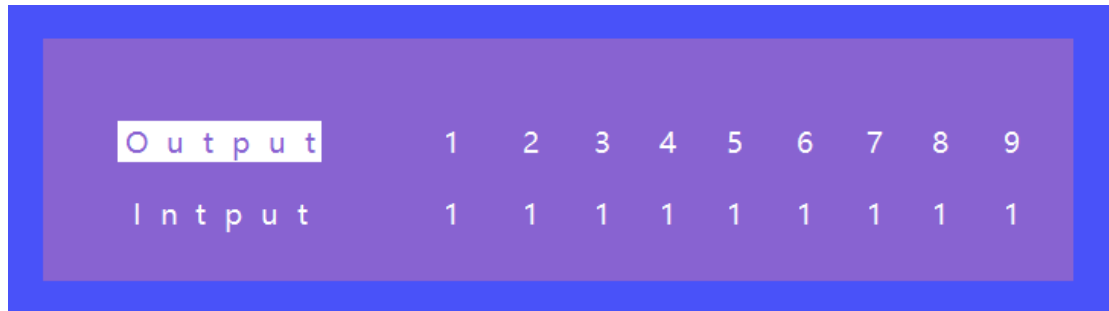

Input/output channel interface

Switch the input to the output

Operation format: "Output channel" + "input channel"

① Switch Output 1 to Input 5

Operation: Press the Output area's number "1" + Press the Input area's number "5" to complete the switch

② Switch Output 2 5 8 to Input 7

Operation: Press the Output area's number: "2""5""8" + Press the Input area's number "7" to complete the switch

③ Switch All output to Input 4

Operation: Long press any number at Output area + Press the Input area's number "4" to complete the switch

④ Enter video wall mode

Operation: Long press any input button number (eg. Button 2)to complete the switch, all outputs will switch to input 2,simultaneously enter videowall mode.

5.1 Video Control

Press “MENU” on panel button,enter main Menu interface:

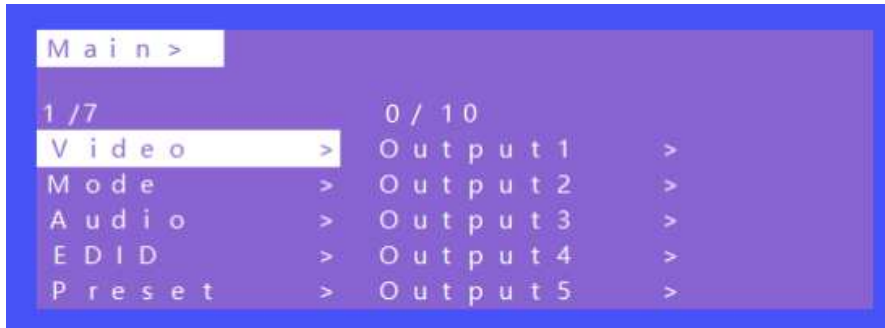

- ① Main Menu functions:
- ② Video: source switch
- ③ Mode: mode switch
- ④ Audio: audio setup
- ⑤ EDID: EDID setup
- ⑥ Preset: preset setup
- ⑦ INFO.: info. query

The video interface has 10 sub-menus: Output 1~9 and ALL.

Each sub-menu has 7 functions: switching(input/source), On/Off (video signal), POC (power switch), Resolution (output), Rotate (180 degree), Mirror, Advanced.



Video Interface

5.1.1 Video Switch

Switch any output to any input or switch all output to the same input

- ① Choose “Video” in the menu and press “ENTER” button
- ② Choose “Output1” and press “ENTER” button
- ③ Press “UP” and “DOWN” to select “Switching”,press “ENTER”
- ④ Press “UP” and “DOWN” to select “Input”
- ⑤ Press “ENTER”,switch video complete.

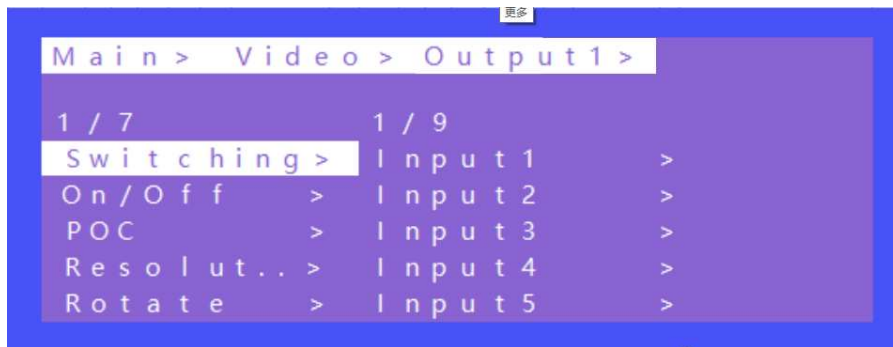

Switch Interface

5.1.2 Video On/Off control

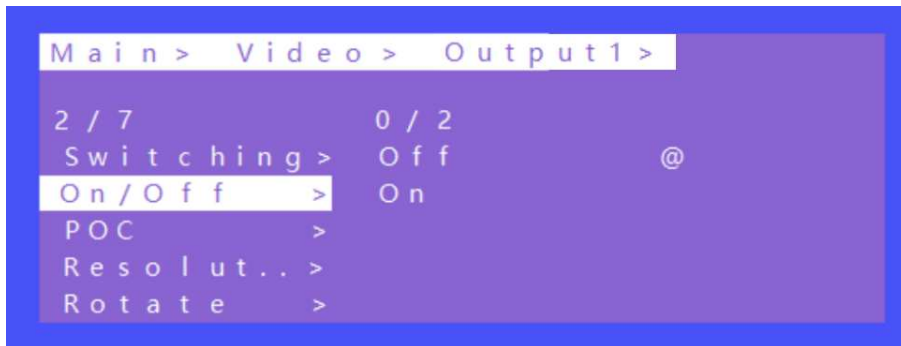

Video On/Off Interface

5.1.3 POC On/Off

Turn on/off any one channel power supply for receiver(12V 3A power).

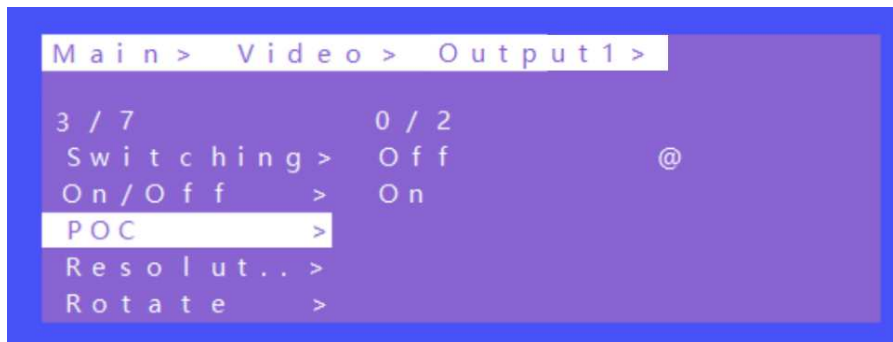

POC On/Off Interface

5.1.4 Output resolution Selecting

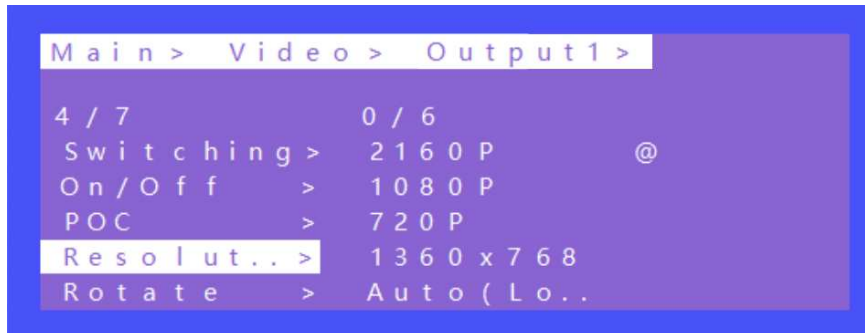

Resolution Format Interface

The output resolution options: 2160P(default), 1080P, 720P, 1360x768, AUTO(local), and AUTO(remote) .

(AUTO is the resolution supported by the automatic identification of the back-end TV).

5.1.5 Rotate

Select any one or all outputs and rotate video(clockwise 180 degree)

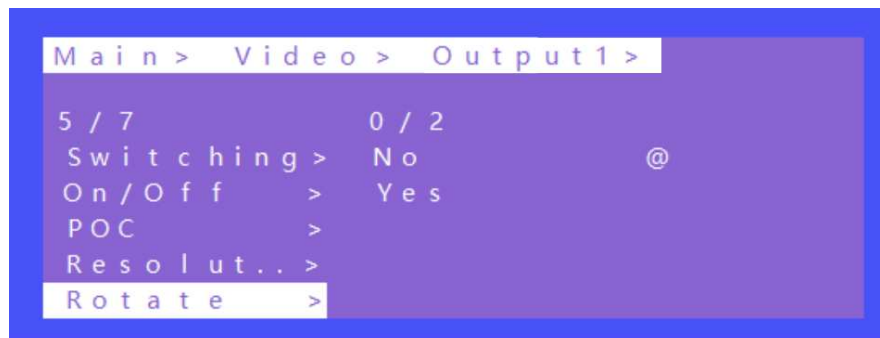

Rotate Interface

5.1.6 Mirror function

Mirror for any one or all outputs video,including options: Normal(default,not mirror), Only X (Mirror Horizontally), Only Y (Mirror Vertically), X and Y (Mirror Horizontally& Vertically,180° rotate).

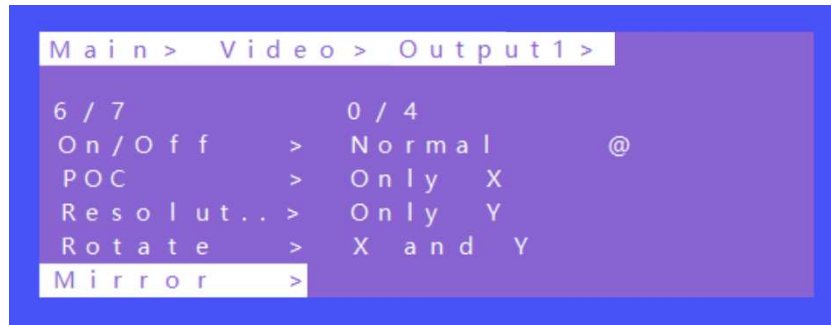

Mirror Interface

5.1.7 Advanced Setup

Choose any one or all outputs for image color setup,including:

Restore: reset all for color setup

Brightness

Contrast

Saturation

Hue

R_Gain (Equivalent to setting the offset degree of the three primary colors)

G_Gain (Equivalent to setting the offset degree of the three primary colors)

B_Gain (Equivalent to setting the offset degree of the three primary colors)

R_Offset (Equivalent to setting the color depth of the three primary colors)

G_Offset (Equivalent to setting the color depth of the three primary colors)

B_Offset (Equivalent to setting the color depth of the three primary colors)

Each one can set 0~100,default 50.



Advanced Interface

5.2 Mode Control

The control interface of Mode has 2 sub-menus: Seamless Matrix; Video Wall;



Mode Interface

5.2.1 Seamless Matrix

Seamless Switch input for all video outputs.

(P2P: output1 choose input1,output2 choose input2,etc.)

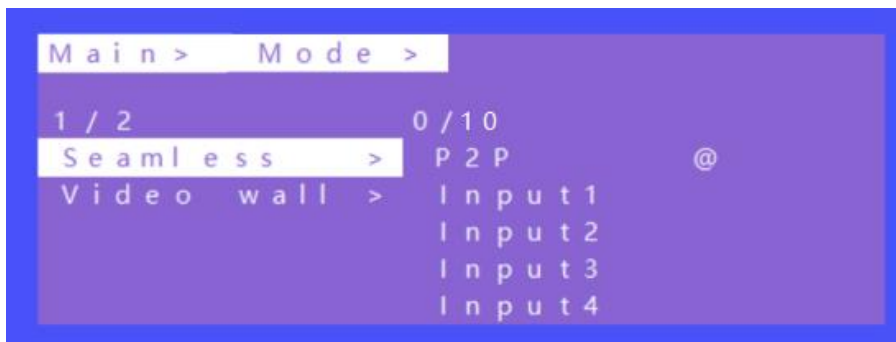

Seamless Matrix Interface

5.2.2 Video wall Mode

There are 4 sub-menus: Preset, Set Up (videowall size), Source (switch input), Offset (horizontal and vertical margin Settings)

A. Preset

There are 20 preset scenes in the Mode.

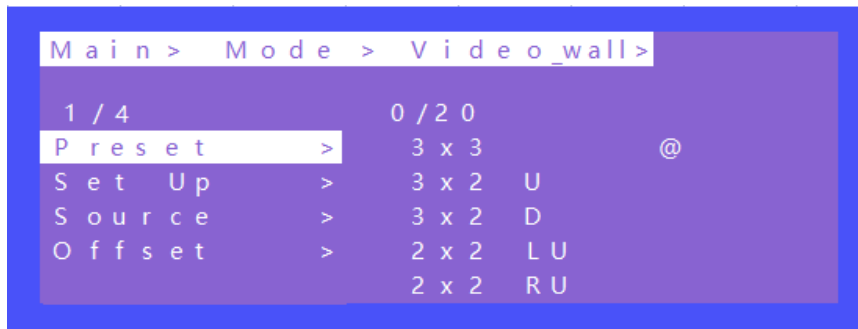

Explanation:

3x2 U means 3x2 Video wall on the TOP Side

2x2 LU means 2x2 Video wall is on the Left Upper side

B. Set Up

H_NUM represents the number of screens on horizontal axis, option 1~10, default 1;

V_NUM represents the number of screens on vertical axis, option 1~10, default 1;

Cascade represents device in which layer for the cascade connection, option 1~12, default 1;

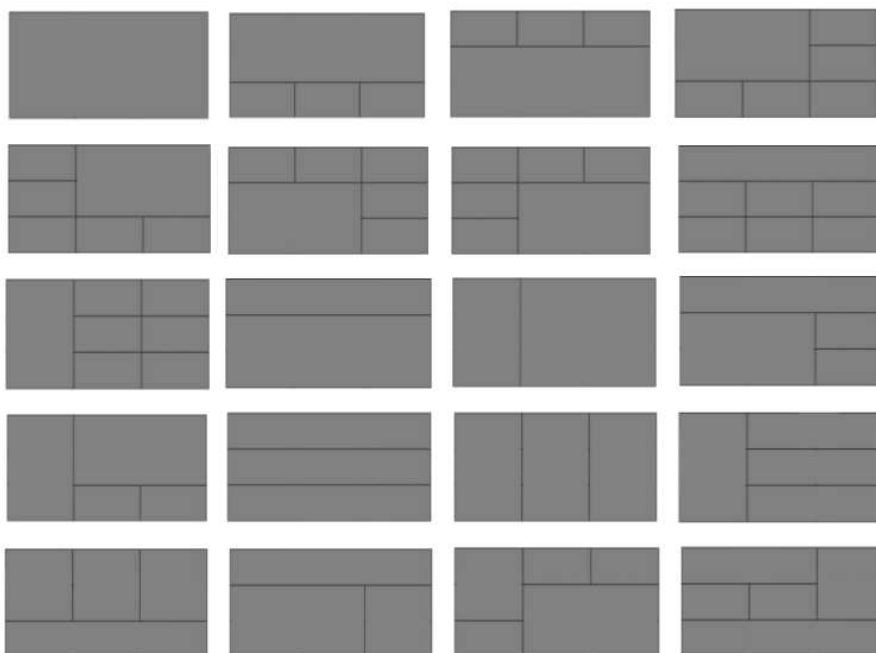
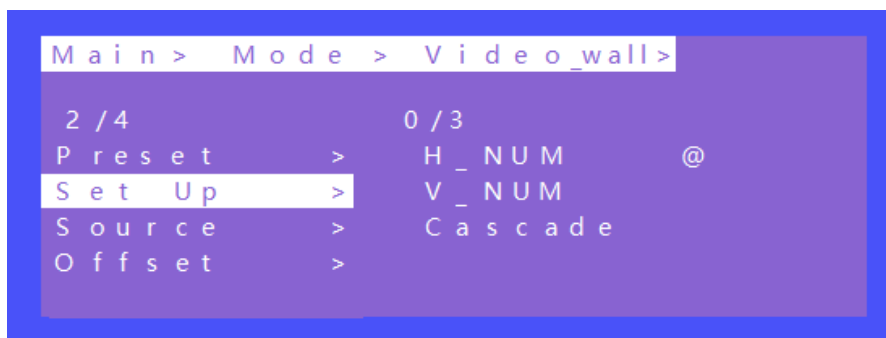

C. Source

To switch input source for videowall.

- ① Use HDMI loopout port to connect next device for cascade when needed
- ② Press “UP” and “DOWN” to select “Source”,press “ENTER”
- ③ Press “UP” and “DOWN” to select “Input1”
- ④ Press “ENTER”,switch video complete.

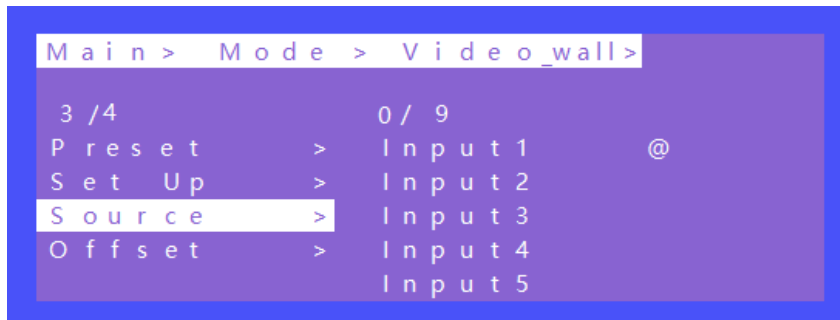

Source Interface

D. Offset

Choose all outputs for offset (horizontal and vertical margin settings) in videowall settings.

- (1) Press “UP” and “DOWN” to select “Offset” under videowall mode,press “ENTER”
- (2) Press “UP” and “DOWN” to select “X” or “Y”(301 options ,0~600,interval 2)
- (3) Press “ENTER”,Offset complete.

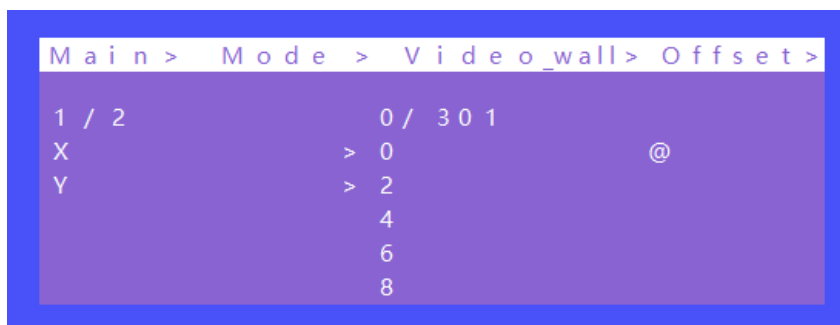
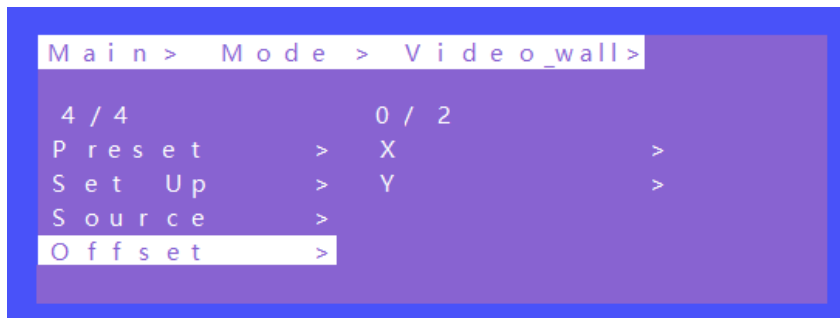

5.3 Audio Setting

There are 10 sub-menus in the Audio Control Interface:

5.3.1 OUT 1~9

5.3.2 ALL

Audio Setting interface can set each or all output together. Mute, Un-mute or Delay can be selected for HDMI/ Analog audio settings.

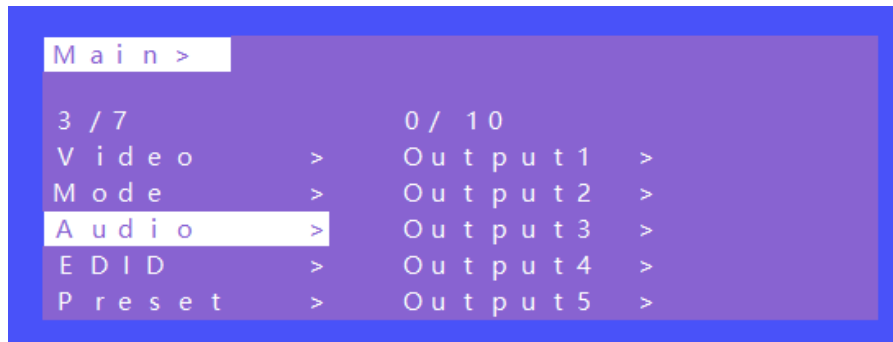

Audio Interface

5.4 EDID Setting

Set each input ports' EDID, there are two resolutions of Built-In EDID: 4K30hz; 1080P;

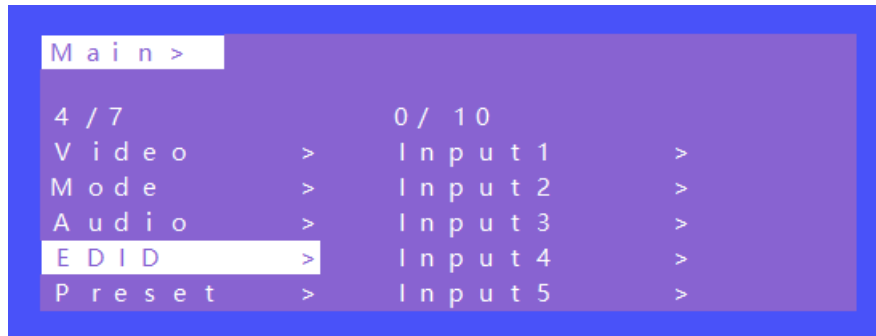

EDID Interface

5.5 Preset setting

5.5.1 Call: Call the preset video

5.5.2 Save: Save the preset setting

5.5.3 Clear: Remove the setting

Total can save 8 different video setting, modify the preset name need to login in WEB page. Then will synchronize to product.

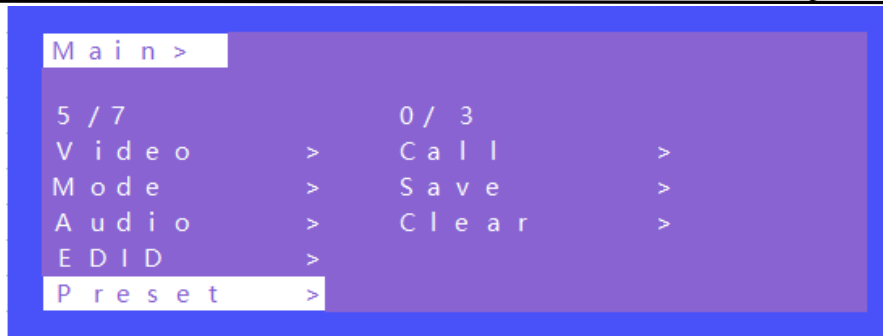

(Note: Preset 1~8 default is P2P mode)

Preset Interface

5.6 Setup Section

5.6.1 OSD Setting

OSD setting with 2 sub-menu:

Menu time: Timing OSD setting in Menu interface

Always means the OSD info will be showed all the time;

60s means the OSD info will be turn off after 60 seconds.

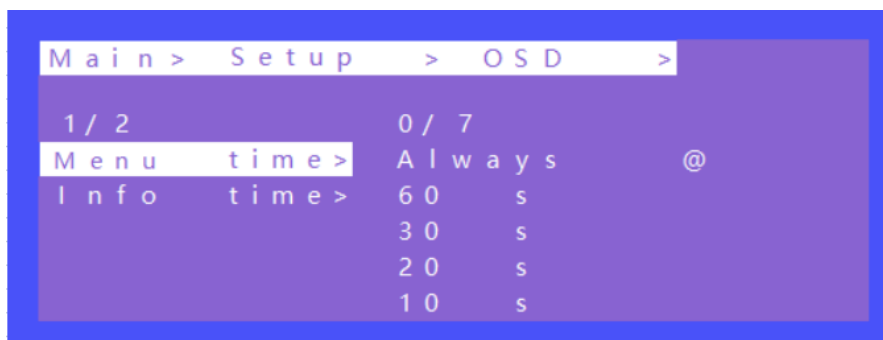

Info time: Timing OSD setting in Resolution information

In Info time setting, with an option “Never” means the Info OSD won’t be showed.



5.6.2 Baud Rate Setting (Default: 115200)

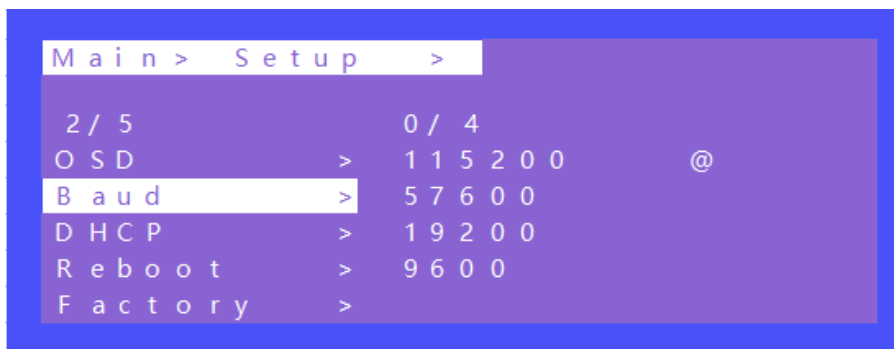

5.6.3 DHCP Setting (Default: DHCP Off)

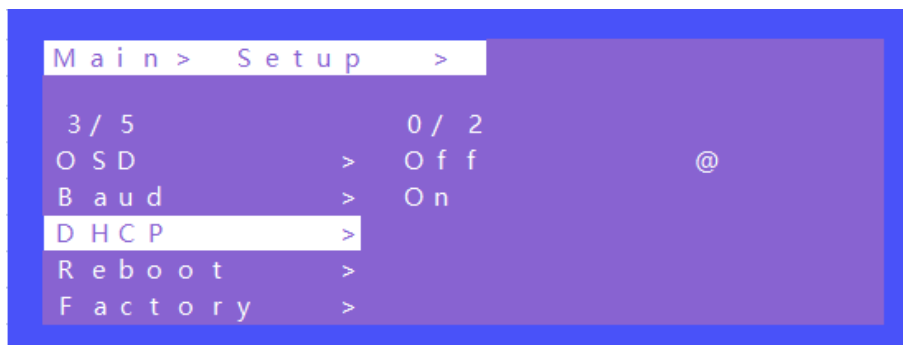

5.6.4 Reboot Setting

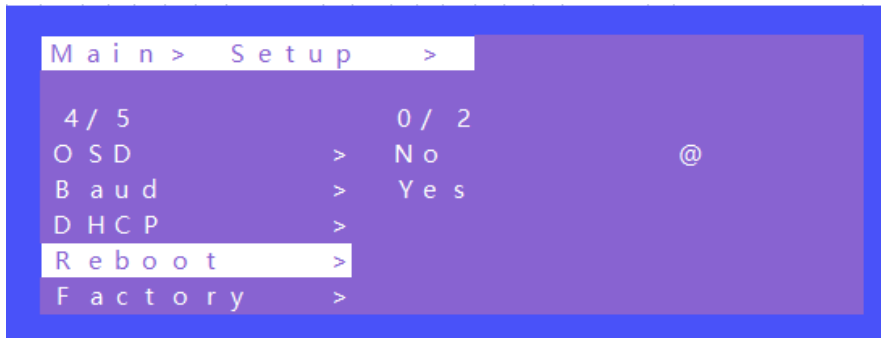

5.6.5 Factory Setting

It is an initialization setting for the device function. There are two factory settings:

- ① Factory-Run
- ② Factory-User

Factory-Run is the recovery operation data. (Keep the Preset setting)

Factory-User can restore the factory settings for all settings.

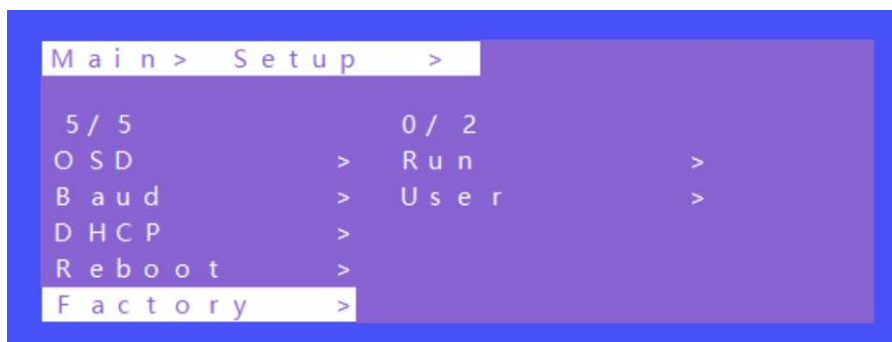

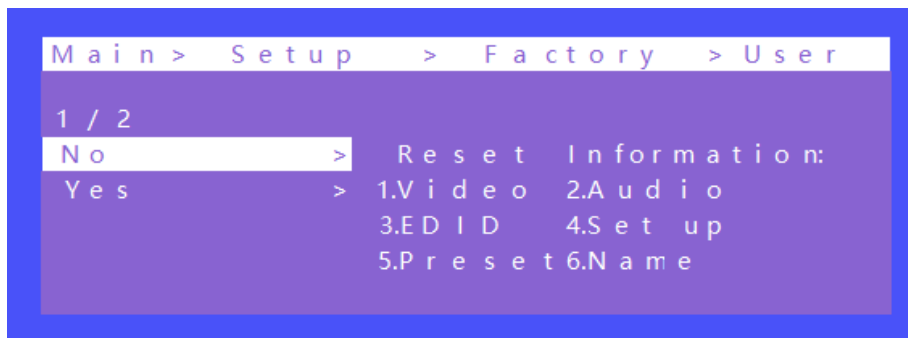



















5.7 Info Section

Query device information, such as IP information, system information, each device MAC is different, IP address default 192.168.1.168





6. Remote Controller

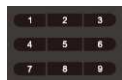

- : Standby or power on
- : Mute button
- : Return to upper level
- : Move to next level
- : (N/A)
- : (N/A)
- : (N/A)
- : (N/A)
- : (N/A)
- : Menu
- : All output
- : Up
- : Left/Menu
- : Right/Enter
- : Right/Enter
- : Down
- : OSD on/off
- : Menu



When selecting Output, means Out1--out9
 When selecting Input, means In1--In9

- : (N/A)
- : (N/A)
- : (N/A)

7. WEB Control:

When the matrix is connected to the control device (such as: PC) through TCP/IP network port, which can be controlled by Command or through GUI man-machine interactive interface.

The control mode is divided into two types:

Be connected with a single non-networked computer for single control;

Be connected to the local area network, make multi - machine control at the same time

Note: web control recommended to use Google, fire fox, Apple(Safari), IE10 above's browser, using other browsers may not be compatible

7.1 Non-networked control

When the Matrix connect with a single non-networked computer through TCP/IP port, Matrix and the control computer network segment are consistent. Directly connection for control; If the network segment is inconsistent, the control computer network segment should be consistent with the Matrix segment, but the IP address cannot be set to the same, the IP address conflict will not be accessible

WEB:

(Default IP address of web page: 192.168.1.168

MASK: 255.255.255.0

GW: 192.168.1.1

MAC: XXX-XXX-XXXX MAC address will change with GUI module)

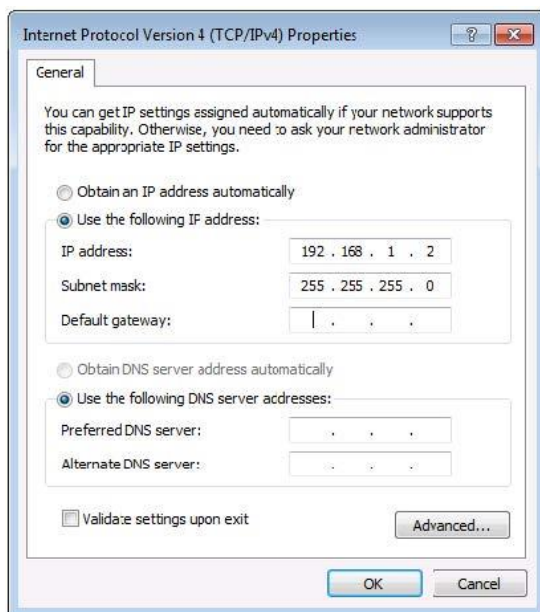

7.2 LAN multiple simultaneous control

Connect to LAN to make the remote control of multi-user devices (such as mobile phones and other PCS) in the Ethernet environment, and ensure that the IP network segment of Matrix is consistent with the IP network segment.

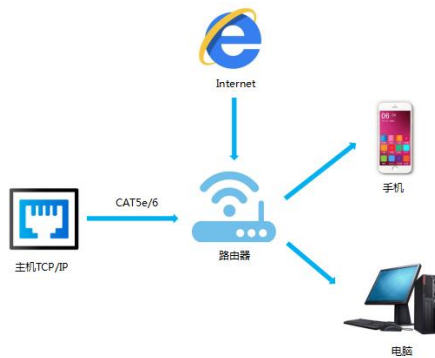

After setting, ENTER the browser and ENTER the default IP address, ENTER the webpage LOGIN interface, ENTER the

Account number: admin

Password: admin

Click LOGIN or press ENTER to LOGIN, as shown in the picture:

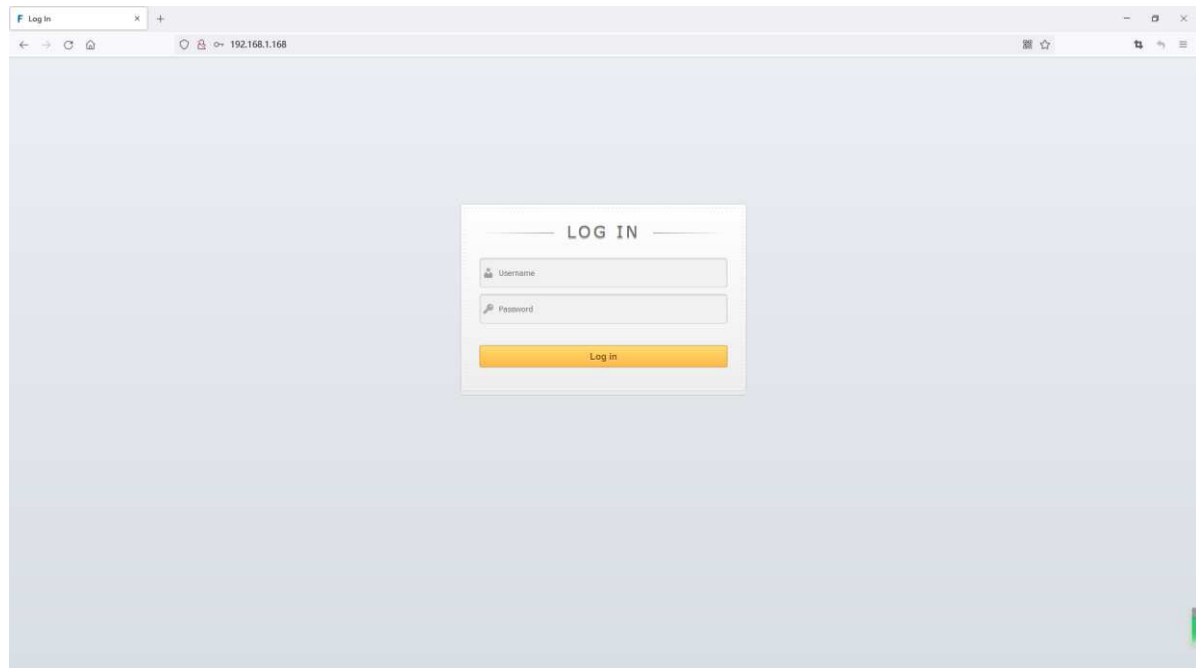

LOGIN Interface

7.2.1 VIDEO Interface

There are four parts: Matrix, Video Wall, Set Up, Prest.

A. Matrix Interface

To switch any input for any output.

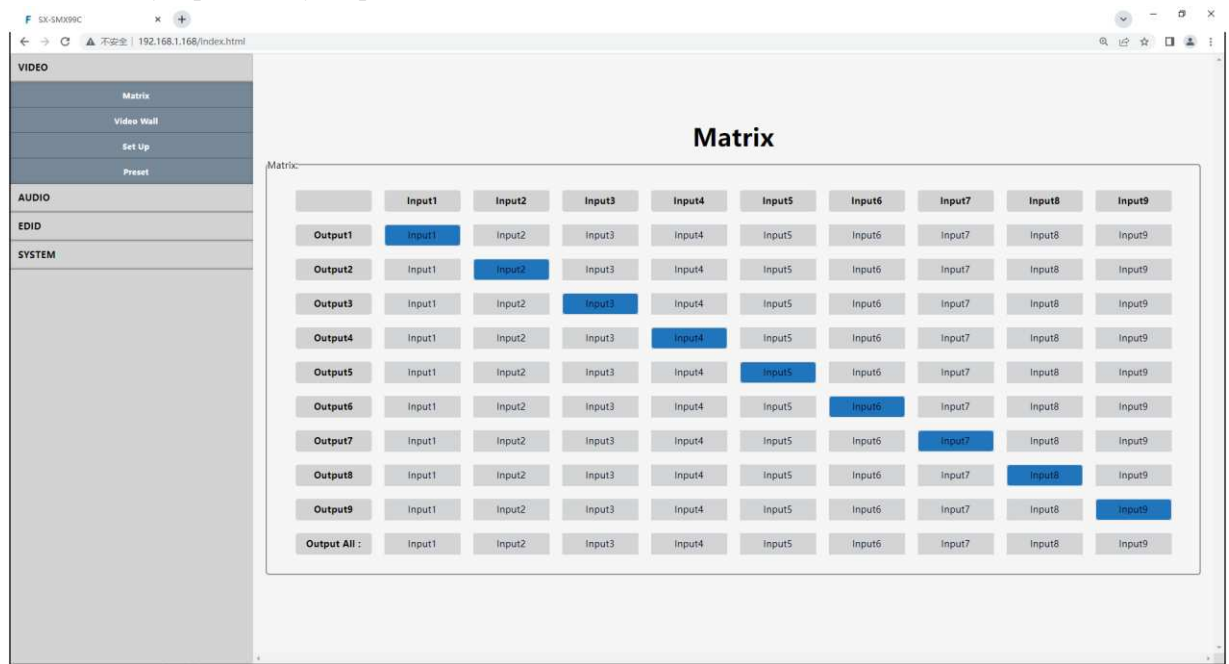

Video Output Interface

B. Video Wall Interface

Set the size of videowall (horizontal/ vertical screen number), cascade number, videowall source, Offset(edge horizontal/ vertical settings).

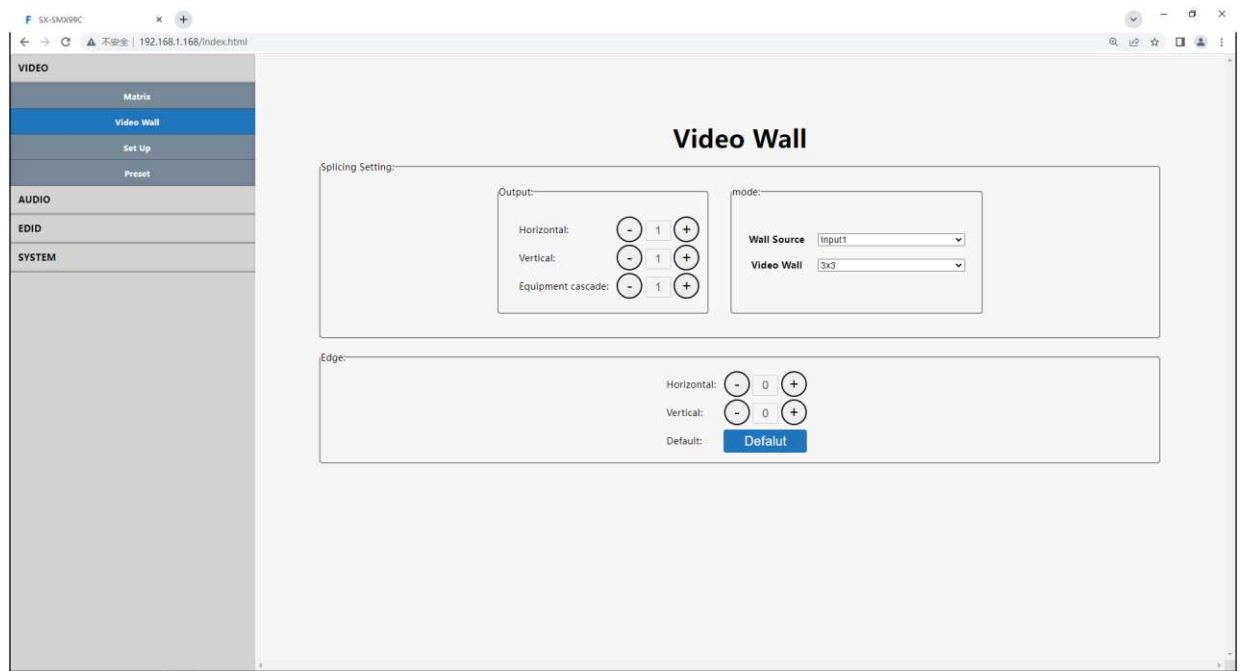

Horizontal/Vertical(screen number),option 1~10,default is 1.

Note: It will auto enter videowall mode once you change settings for “Horizontal” or “Vertical”.

Equipment cascade, means the current device in which layer in this cascade connection,option 1~25,default is 1.

Wall Source, can choose any input 1~9 for videowall.

Edge Settings, choose any one output or all outputs for the offset setting of video screens.

Edge Horizontal/Vertical range 0~600 (interval 2,total 301 options,default 22)

Click +/- button, to do the adjustment.

Click Default button, back to default edge 22/22 (3.5mm)

C. Set Up Interface

Include: Rename for each output, POC power on/off, turn on/off output video, Rotate switch, Mirror settings, Output Resolution settings(**default 2160P**, 1080P, 720P, 1360x768, AUTO local, and AUTO remote).

AUTO means the resolution supported by the automatic identification of the back-end TV.

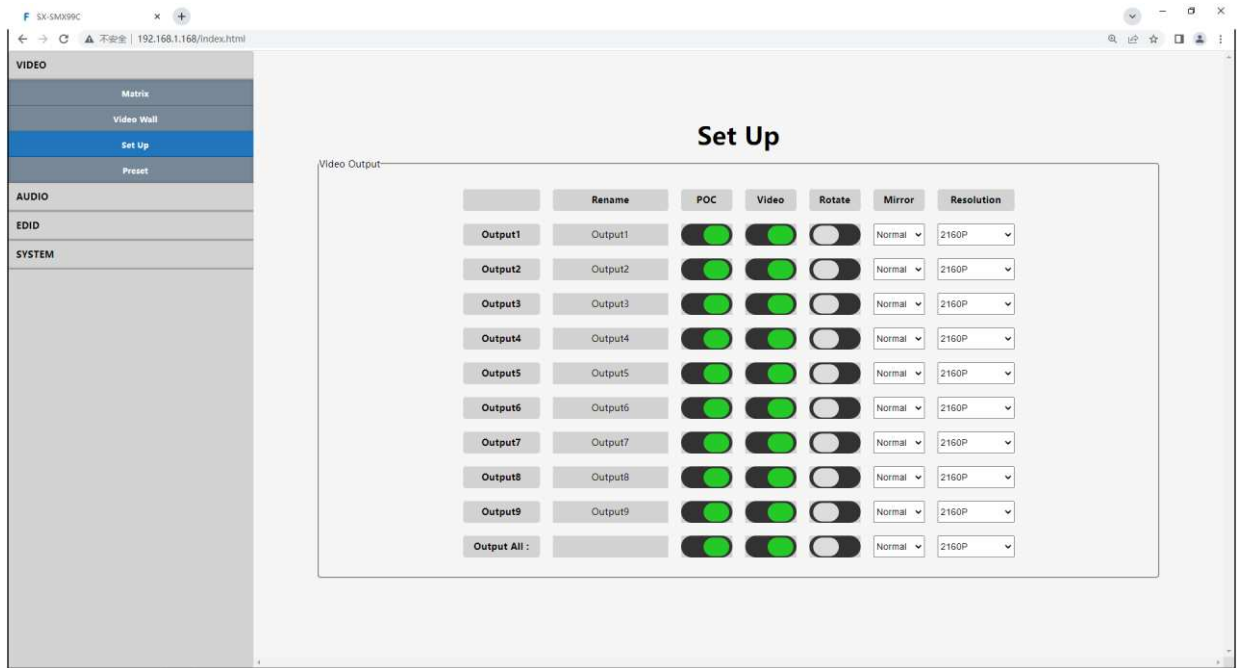

Note: double click to rename for each output.

D. Preset Interface

Rename for each Preset scene, Save/ Call/ Clear preset.

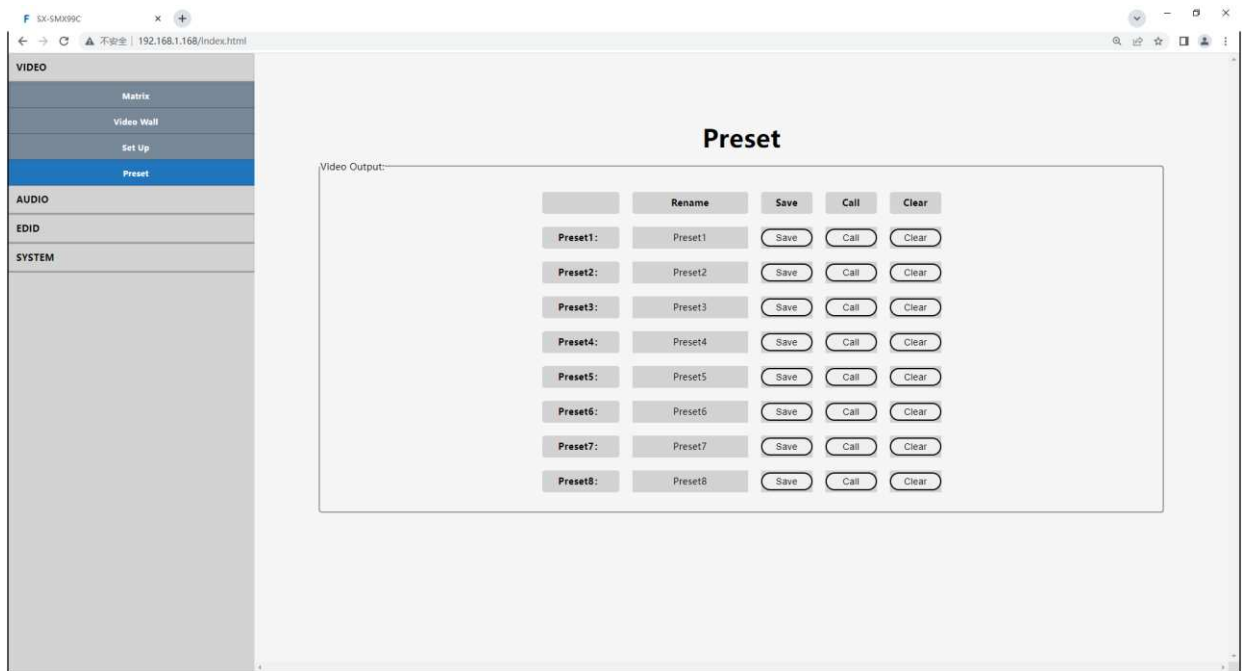

7.2.2 Audio Interface

Turn on/off output audio, adjust delay time for output audio.

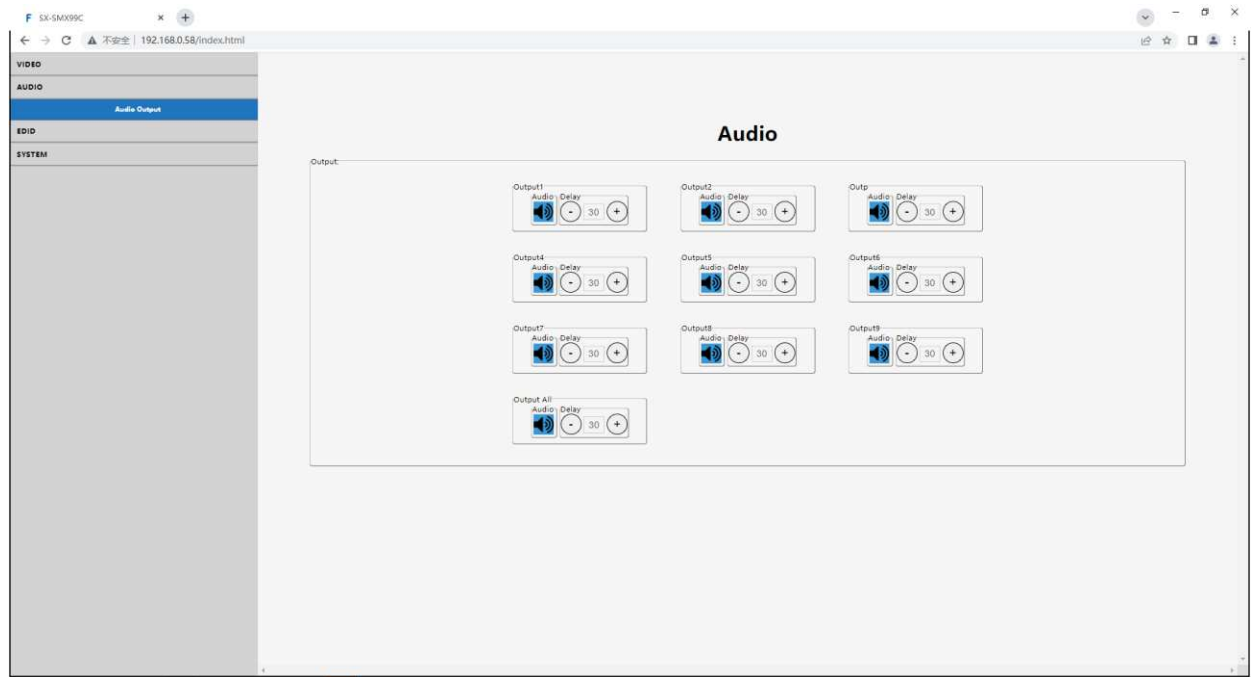

7.2.3 EDID Interface

Double click to rename for each input, and copy 2 build-in EDID for input(4K30, 1080P).

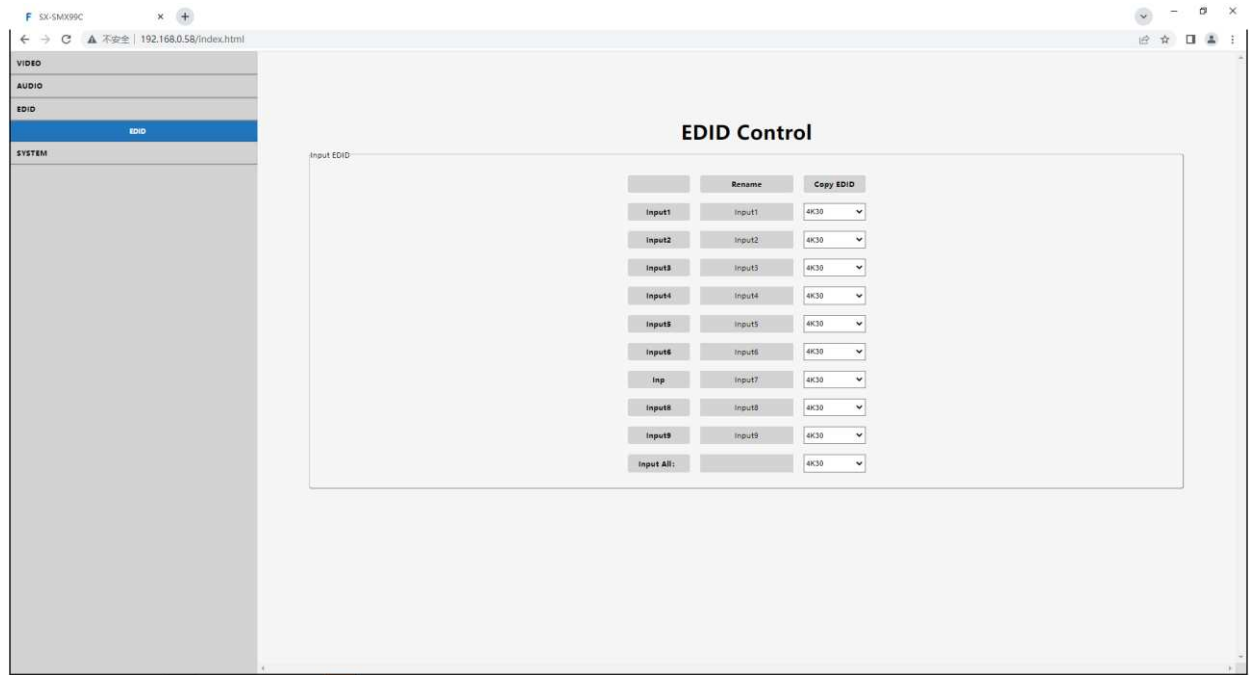

7.2.4 SYSTEM Interface

Include: **Network, Reset, Password.**

Network interface: set and display IP informations.

MAC address can not be modified, for display only.

Static IP: When DHCP off, you can modify static IP address, take effect after application, it will auto need to log in web interface again after 8s countdown.

Dynamic IP: When DHCP on, you can not modify IP address(change into grey), only display the current IP address.

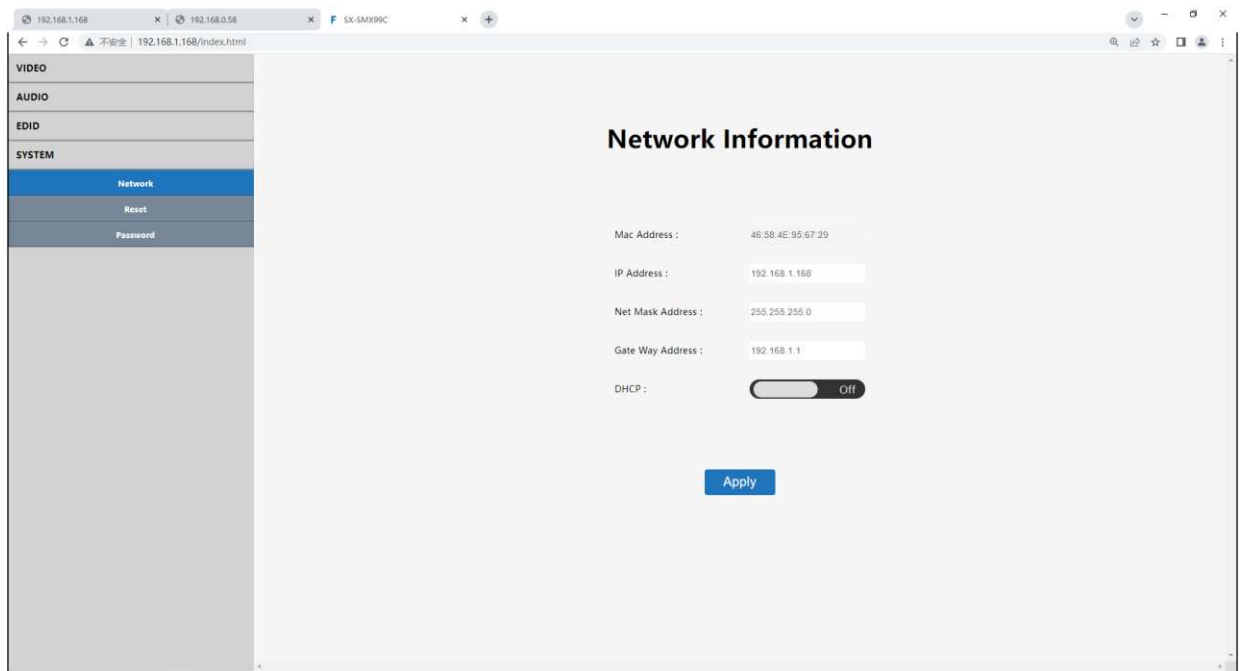

Reset Interface

Reboot: Reboot device.

Factory Run: Restore running data like the settings for Video, Audio, EDID, Setup (Keep the Preset setting).

Factory User: Restore the factory settings for all settings.

Standby: click to enter standby mode, click again to wake up device.

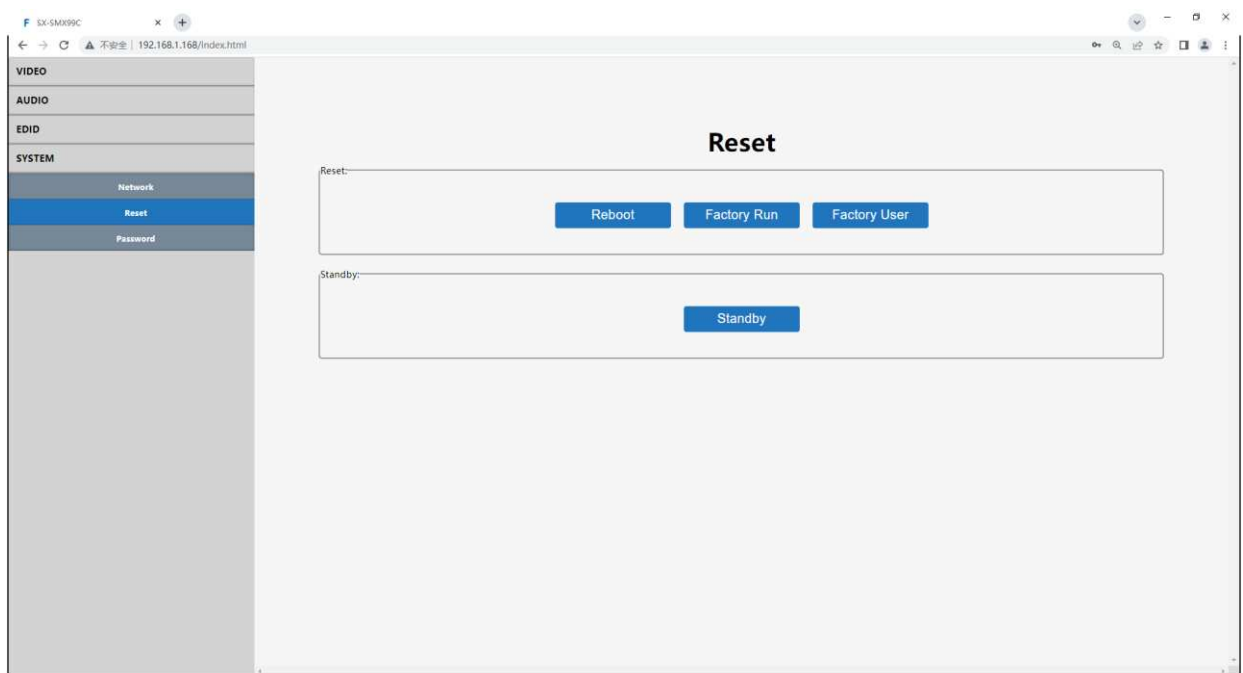

Password Interface

Modify password for current log in account

Default Account: admin

Default Password: admin

(Only support 5~15 bits, support alphabets/numbers/underline)

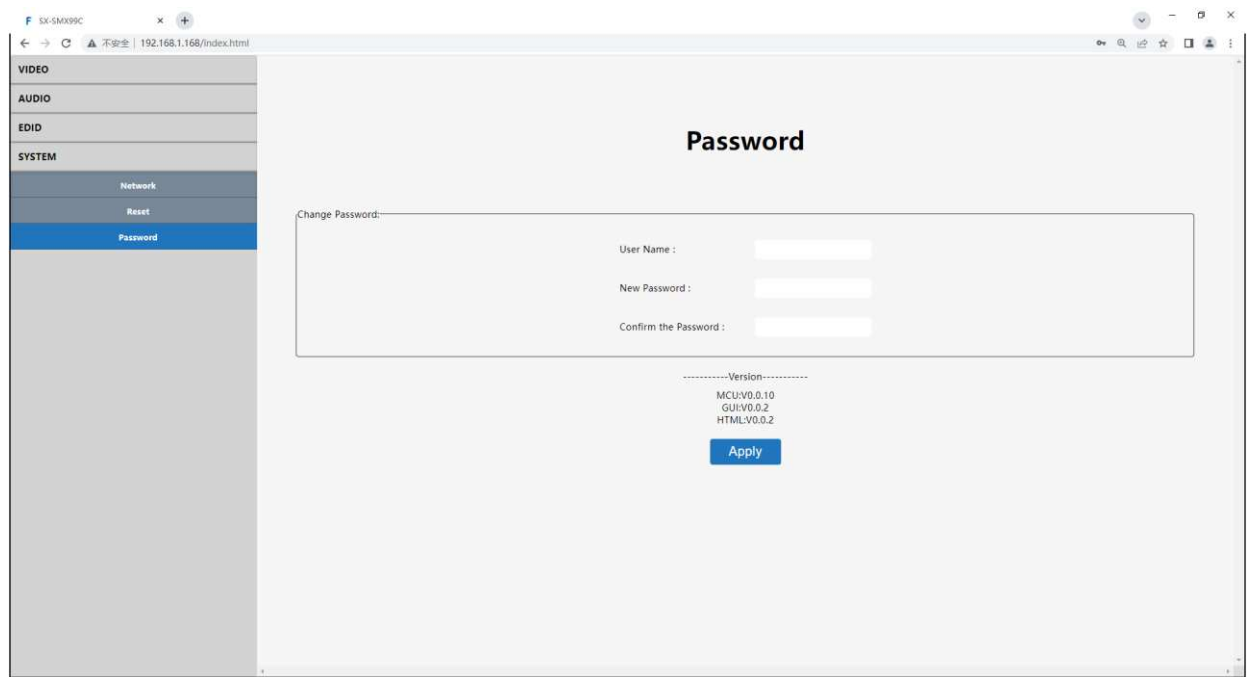

8. RS232 Control

Control software operation:

The serial control software is illustrated with SSCOM32 as an example.

Basic Settings:



Double-click the software in the installation package to run specifically (as shown in figure 1 below) and install the RS232 software on the computer. Enter the main interface of the software, as shown in the figure below.

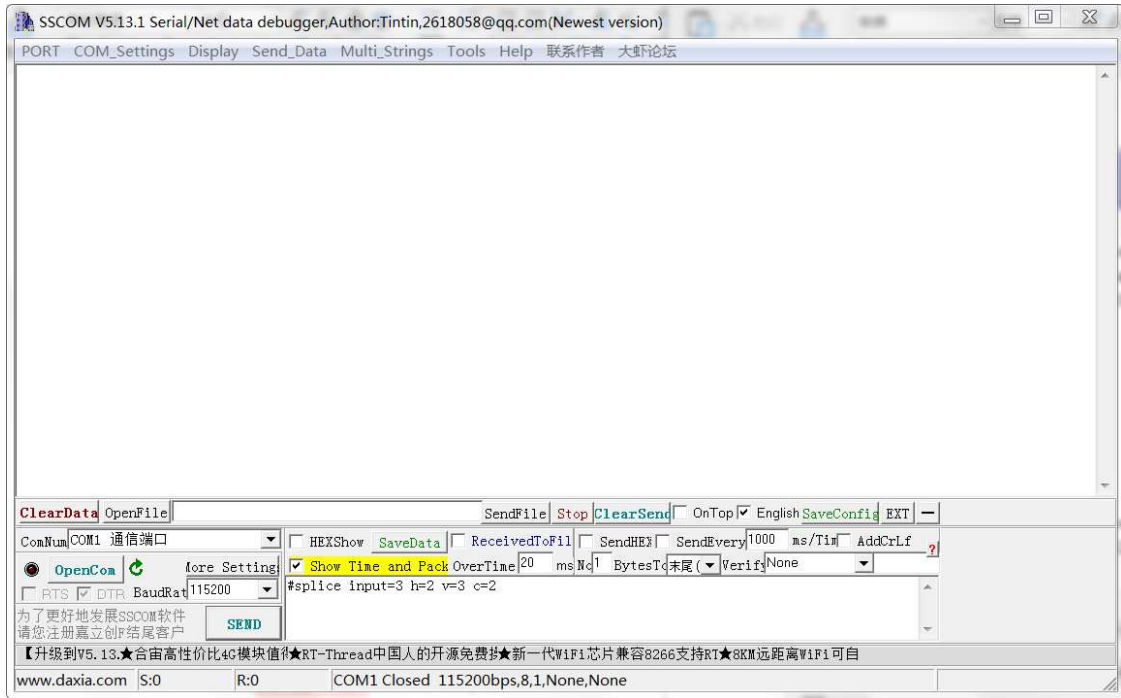

In the parameter configuration area, select the serial port number that the serial line connects to the PC

Baud rate: 115200 (default)

Data location: 8.

Stop bit: 1

Check bit: no

Then can input commands in the command input area to control the local or remote receiver

Instructions:

- 1. All commands start from "#", command head "%c": "d" parameters, "l" lock.
- 1. The "_" in the commands cannot omit. Parameter: %d: 0 means ALL, 1-x means specified output(1~9).
- 2. Command head & Parameter1 & Parameter2... need to add one "SPACE" between them.

The following table is only an example. Please refer to the list of instructions.

Instruction description	instruction	parameter 1	parameter 2	parameter 3
Video switch	#video_%c	out%d	in%d	matrix=%d
Audio Mode Switch	#audio_%c	in%d	/	enc=%d
EDID	#EDID_%c	In%d	cfg=%d	/

Please refer to the " Command list" for details.

Example: videowall input switch to input3, videowall mode 3×2 , cascade layer 2.

Operation format: #splice input=3 h=2 v=3 c=2

9. IR System

The matrix can pass the IR signal through the IR system to the HDMI source or pass the IR signal from the HDMI source to the HDMI sink.

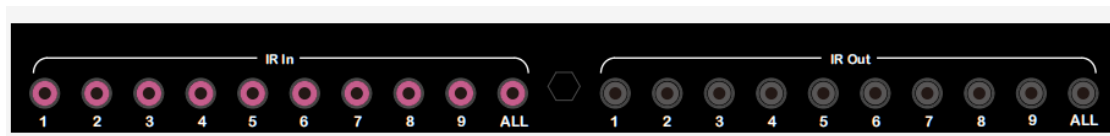

Dual way IR using:

- Step1: "IR IN" is for UTP output, "IR OUT" is for input channel
- Step2: "IR IN ALL" Controlled by all input IR; "IR OUT ALL" Controlled by all output IR.
- Step3: Receiver support connect with IR receiver to control the Matrix by remote
- Step4: Matrix IR channel "IR IN" support connect with IR-RX cable to control the Matrix.

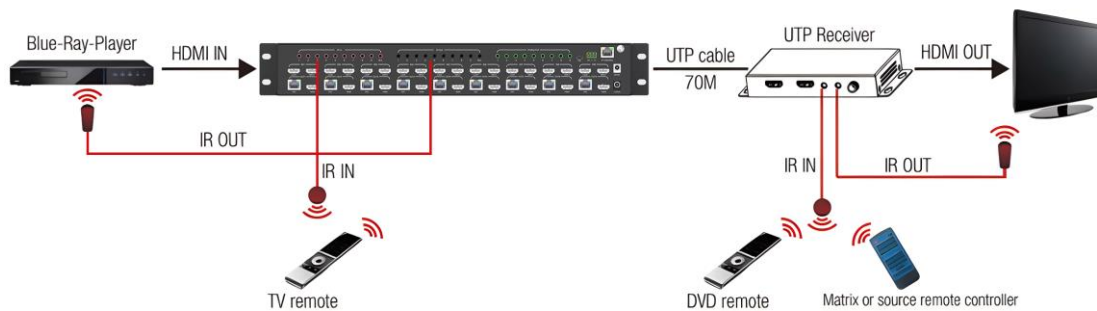

10. Firmware updating

Open software UART_ISP.exe on the PC, select the correct port and baud rate of 115200, type in "A1" in PORT, and select the path of the program in PATH (XX.bin), then click UPDATA to complete the upgrade

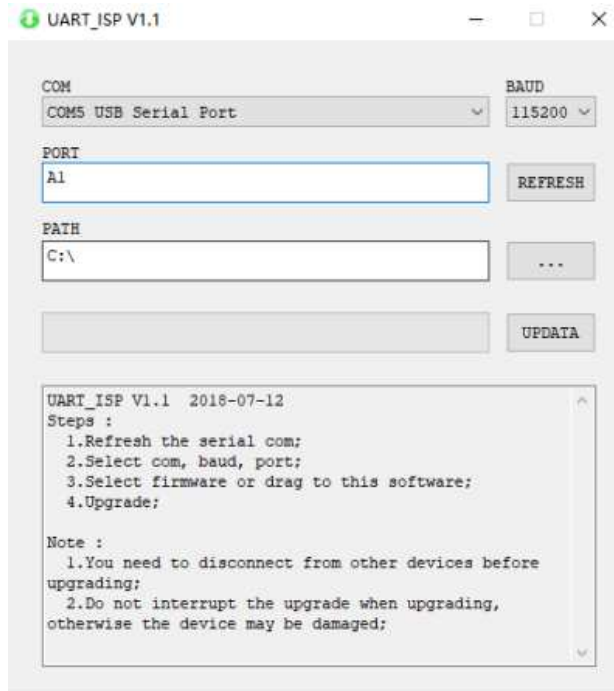

MCU Updating: A1

CPLD Updating: C0

GUI Updating: A1 01

HTML Updating: F1 01

(NOTE: Every time you need to update the firmware, please check with the Engineer first)

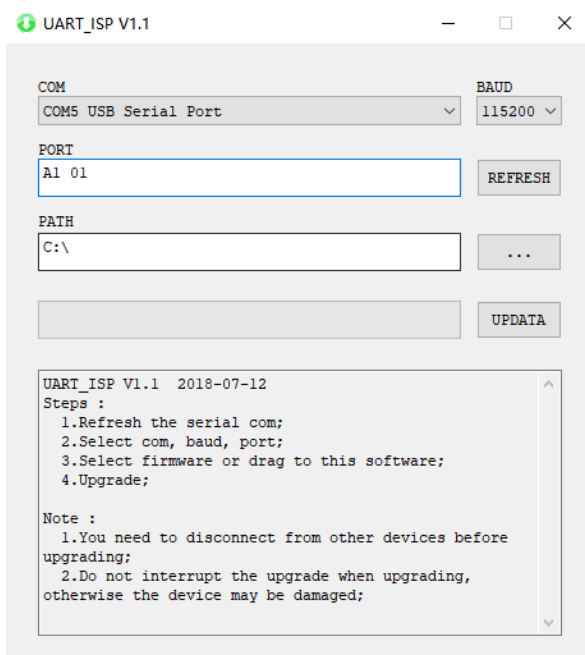

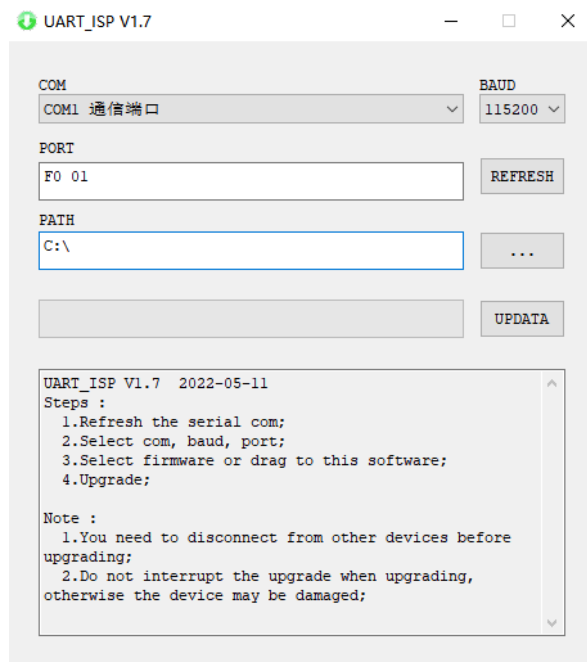
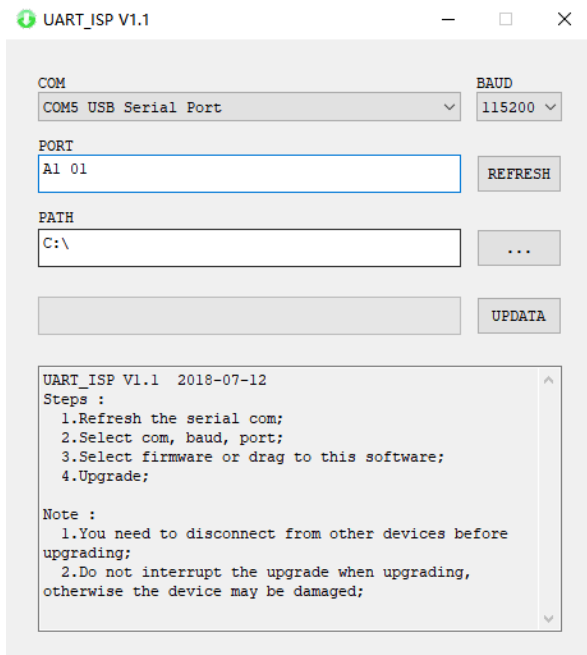

11. Application Diagram

① Seamless switch 9x9 HDMI Matrix

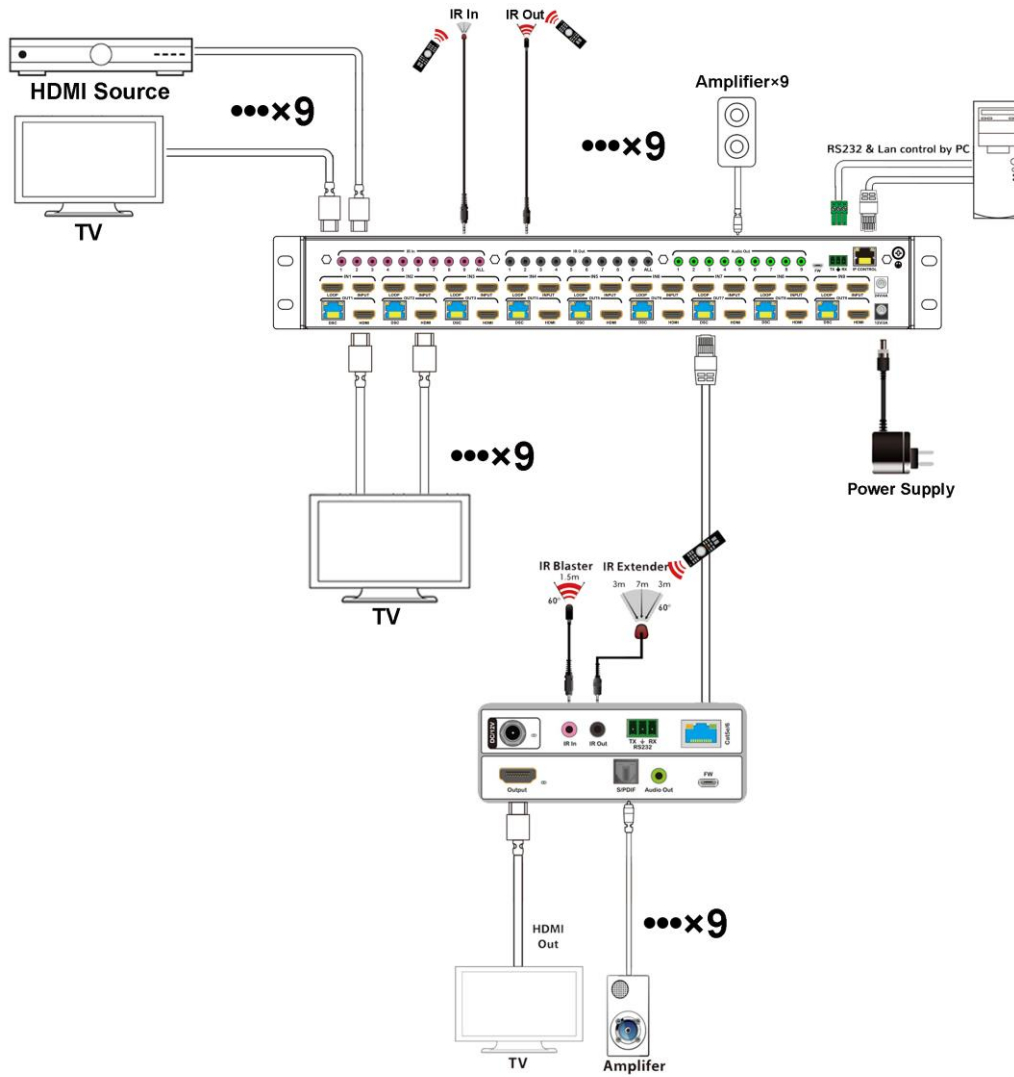

② Diagram of 3x3 Video Wall Displaying

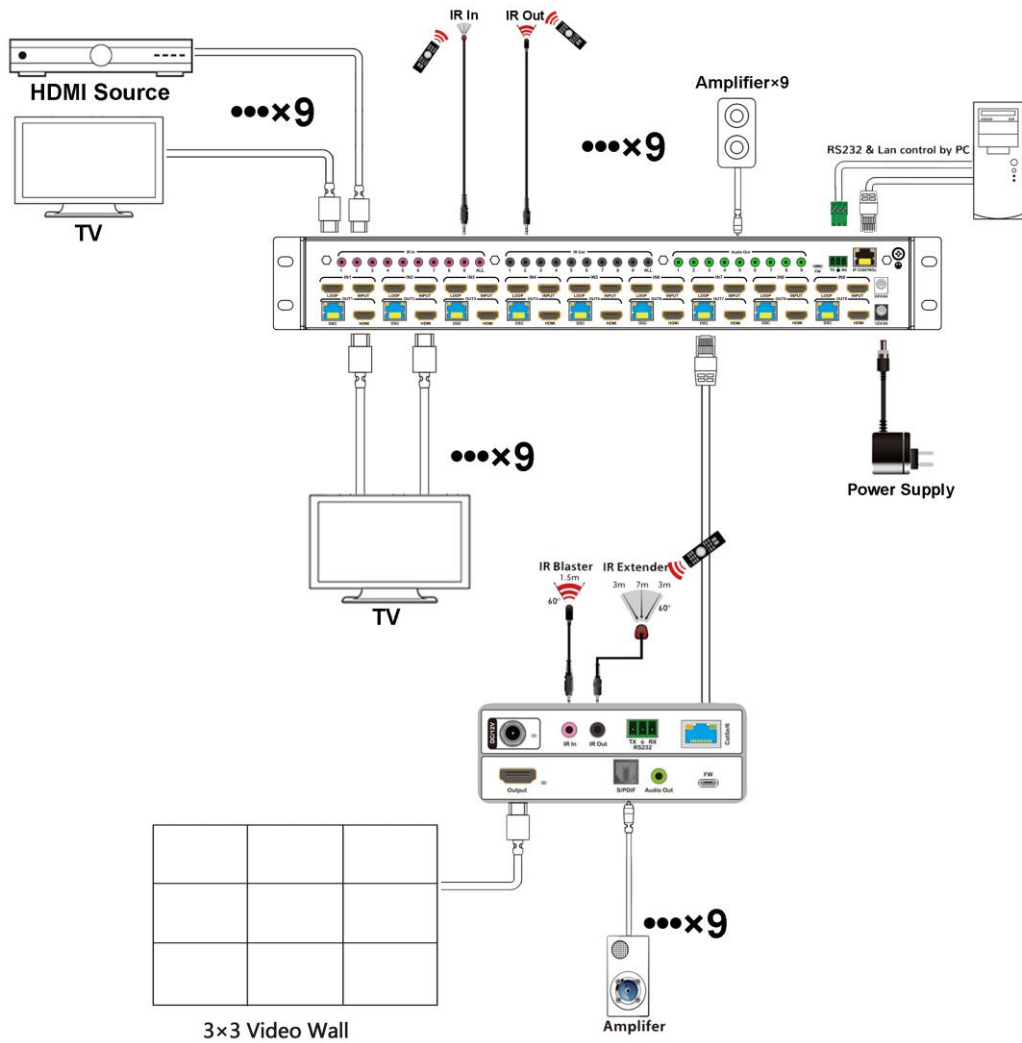

MAINTENANCE

Clean this unit with a soft, dry cloth. Never use alcohol, paint thinner or benzine to clean this unit.

PRODUCT SERVICE

(1) **Damage requiring service:**

The unit should be serviced by qualified service personnel if:

- (a) The DC power supply cord or AC adaptor has been damaged;
- (b) Objects or liquids have gotten into the unit;
- (c) The unit has been exposed to rain;
- (d) The unit does not operate normally or exhibits a marked change in performance;

The unit has been dropped or the cabinet damaged.

(2) **Servicing Personnel:** Do not attempt to service the unit beyond that described in these operating instructions. Refer all other servicing to authorized servicing personnel.

(3) **Replacement parts:** When parts need replacing ensure the servicer uses parts specified by the manufacturer or parts that have the same characteristics as the original parts. Unauthorized substitutes may result in fire, electric shock, or other Hazards.

(4) **Safety check:** After repairs or service, ask the servicer to perform safety checks to confirm that the unit is in proper working condition.

WARRANTY

If your product does not work properly because of a defect in materials or workmanship, our Company (referred to as "the warrantor") will, for the length of the period indicated as below, **(Parts)2 Year, Labor(90) Days** which starts with the date of original purchase ("Limited Warranty period"), at its option either (a) repair your product with new or refurbished parts, or (b) replace it with a new or a refurbished product. The decision to repair or replace will be made by the warrantor.

During the "Labor" Limited Warranty period there will be no charge for labor.

During the "Parts" warranty period, there will be no charge for parts. You must mail-in your product during the warranty period. This Limited Warranty is extended only to the original purchaser and only covers product purchased as new. A purchase receipt or other proof of original purchase date is required for Limited Warranty service.

MAIL-IN SERVICE

When shipping the unit carefully pack and send it prepaid, adequately insured and preferably in the original carton. Include a letter detailing the complaint and provide a day time phone and/or email address where you can be reached.