



IP Media Player
29-0119 - MPDS-100
User Manual

Index

1. Product Description.....	3
1.1 Main Features	
2. Shipping Group.....	4
3. System Requirement.....	4
4. Exterior Description.....	5
5. Installation.....	6
5.1 Hardware Installation	
5.2 Reset and Factory Reset	
5.3 PC Program Installation	
6. Start Using MPDS-100.....	7
6.1 Local GUI	
6.2 Remote Control	
7. Product Specification.....	16
8. Warranty.....	17

1. Product Description

29-0019 MPDS-100, Full HD(1080p) Media Player, is an integrated playing device that plays video/audio files, different types of documents as well as real-time streaming of IP camera(encoder) based on TCP/IP network. With the control program, this device can play contents to designated place by preset schedule and display the caption on the screen. MPDS-100 can be used for advertisement using video, can be used for security or broadcasting using IP camera, as well as can be an optimal solution for remote lecture using video width PDF, MS office documents.

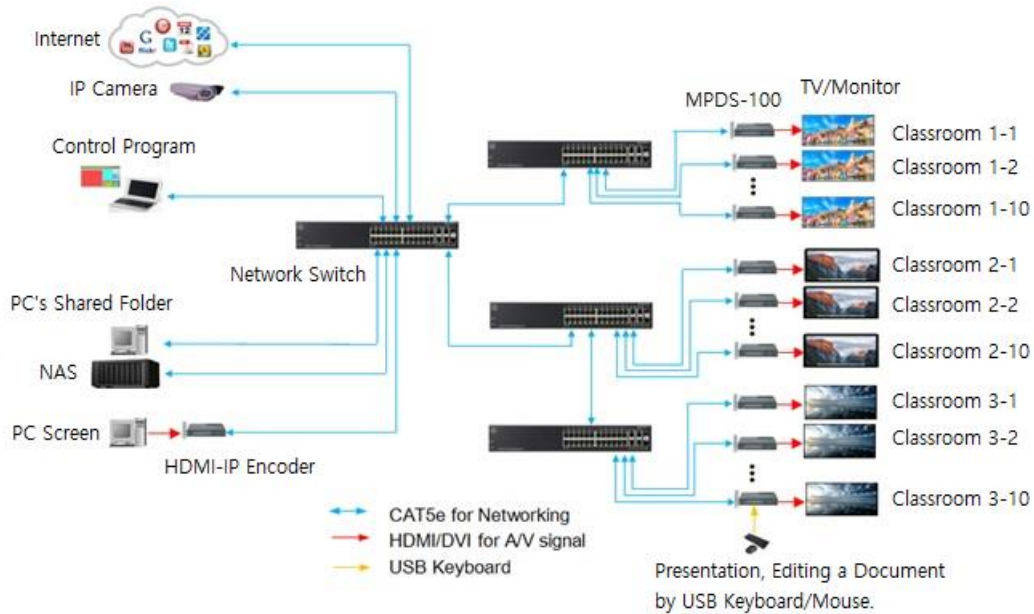
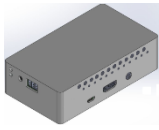

Figure 1. Connection

1.1 Main Features

- H.264 Codec Media Player supports Full HD(1080p) resolution based on TCP/IP.
- Provides HDMI output, Analog audio output, RS-232 port for external device control.
- Supports various sources such as Documents (PDF, MS Office and etc), Video files, YouTube, IP Camera(encoder), Picture, Audio files.
- Remote Control Program
 - Up to 100 groups x 99 presets = 9,900 display configuration and preset file save/load
 - Immediate play by group, scheduling (weekly/sequence)
- Self-GUI
 - Enables to use web browsing, file explorer, video player features.

2. Shipping Specification



MPDS-100



Power Adapter



HDMI Cable 1.2m

2.1 General items

- MPDS-100
- AC / DC power adaptor: One (1) unit of 5V / 2.5A.
- One (1) HDMI male to male cable (1.2m).

2.2 Optional items

3. System Requirement

3.1 Hardware Requirement

- Device doesn't support wireless feature, however, wireless feature can be used with using Wifi/Bluetooth dongle.
- No special requirement for memory size, CPU speed or chipset.

3.2 Software Requirement

- No special requirement.

3.3 Control PC Requirement

- OS version check for MPDS-100 control PC application.
- Requirement: Windows 7 or higher.

3.4 AC / DC Power Adapter

- MPDS-100 is designed to use +5V AC/DC external power adapter

4. External Description

4.1 Input/Output port

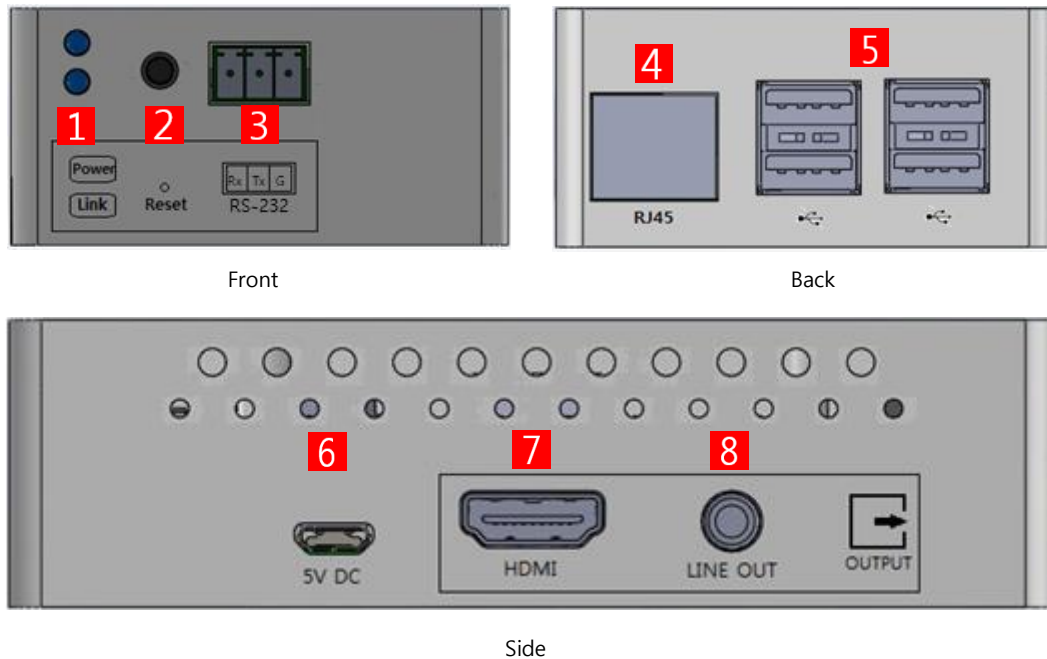

Figure 2. MPDS-100 Input/Output port

- 1** LED : Power LED (RED) / Link LED (GREEN).
- 2** Reset : Reset button. (Factory reset when pushing 5 seconds.)
- 3** RS-232 : Optional.
- 4** RJ-45 (LAN): Connection with RJ-45 Network Cable
- 5** USB : USB2.0 4 Port
- 6** Power : 5V DC power input to the device
- 7** HDMI Output : HDMI video/audio output
- 8** LINE OUT : Analog audio output

4.2 LED Indication

MPDS-100 indicates its power and network condition with 2 LED light on the front.

- Power status LED (RED).
 - 'Flashing' Booting, initializing status.
 - 'On' Completion of booting, working status.
- Link LED (Green).
 - 'On' Connection with network link.
 - 'Off' Disconnection with network link.

5. Installation

5.1 Hardware Installation Procedure

Important: Please follow below procedure. If not installed properly, it could suffer malfunction.

Step 1

Unpack the package.

Step 2

Turn on network storage (or PC), Display, Network Switch(L2/L3)

Step 3

Turn on the PC that has installed MPDS-100 PC application and connect LAN cable (CAT5e/CAT6) to network switch.

Step 4

Connect MPDS-100 to network switch with using LAN cable (RJ-45)

Step 5

Connect MPDS-100 to monitor (HDMI OUT). If using external speaker, connect MPDS-100 to speaker (LINE OUT)

Step 6

If needed, connect Keyboard/Mouse for local UI control.

Step 7

Connect 5V power adapter.

5.2 Reset and Factory Reset

- ◆ Reset : Device will reboot when reset button is pressed shortly
- ◆ Factory Reset: Press and hold reset button for approximately 5 seconds, then LED of device will turned OFF for factory reset after LED blinking.

6. Start Using MPDS-100

With using local GUI and control PC program, MPDS-100 can be utilized for best performance.

6.1 Local GUI

(1) Entering local GUI

Enter local GUI by clicking hot key (Ctrl + Shift + Alt + Back Space or right Ctrl + Enter) with connected keyboard.

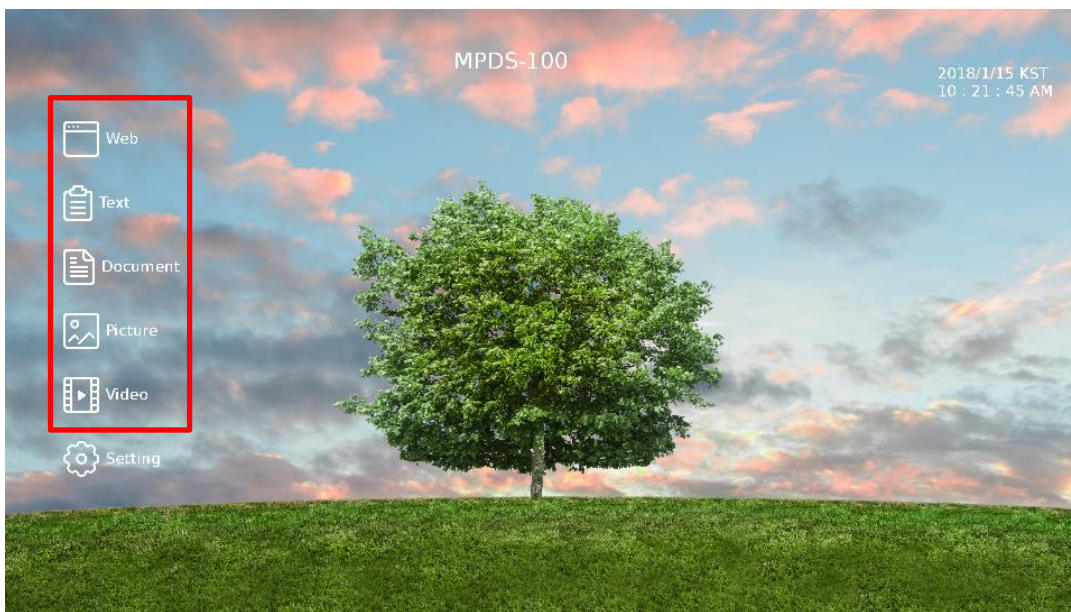

(2) From local GUI, can be Web browsing or can be displaying text, document, picture or playing video from Network Attached Storage(NAS) or connected USB flash drive.

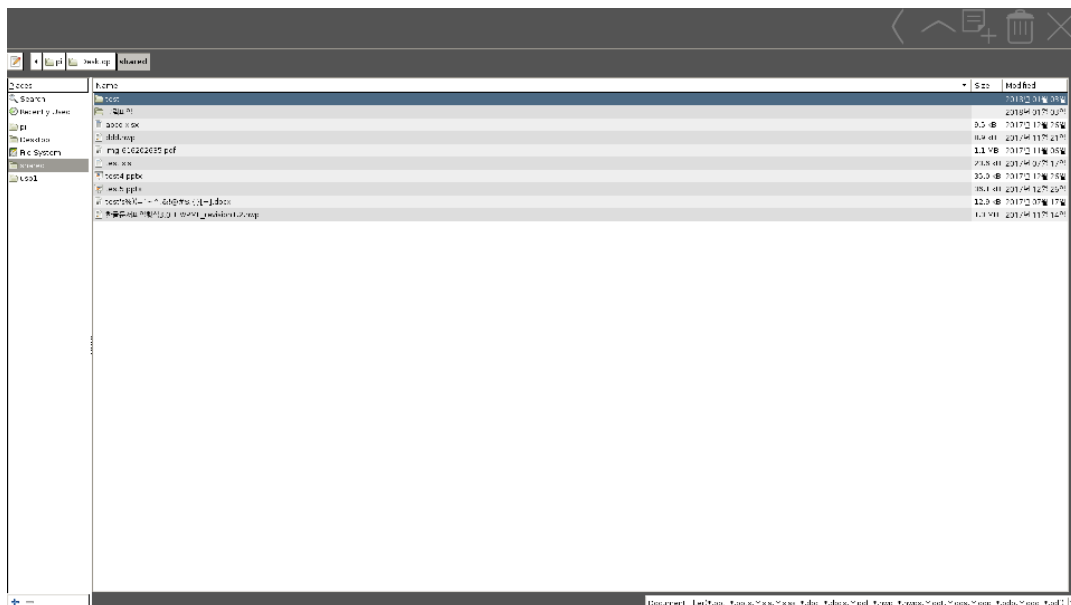

(3) Exit and switch to remote control mode.

Click ESC key of connected keyboard to exit local GUI and switch to remote control.

6.2 Remote Control

(1) Launch MPDS-Controller program.

(2) Register password for administrator (ID : admin) when first-time log-in.

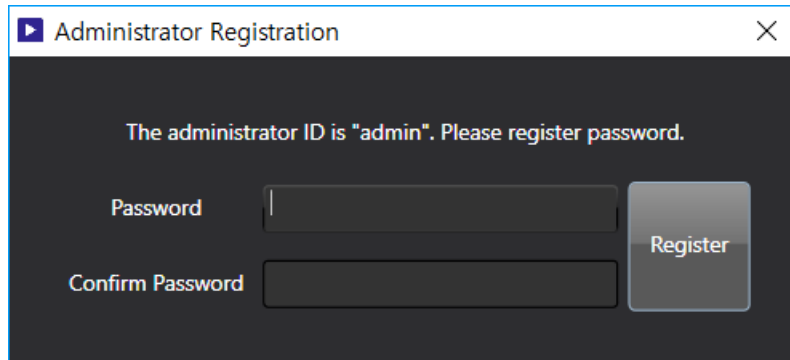

The administrator ID is "admin". Please register password.

Password

Confirm Password

Register

(3) Log-in with Admin ID and set password.

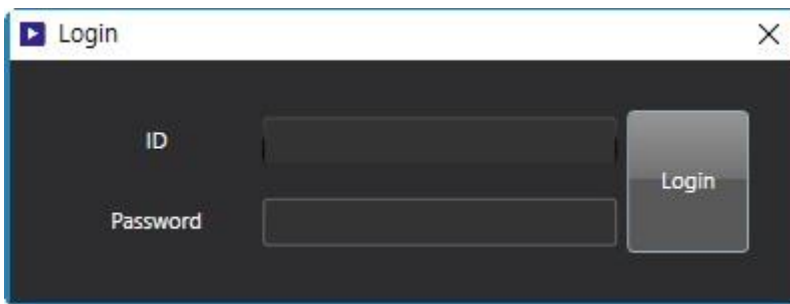

ID

Password

Login

(4) Setup > User Management: Add/Change/Remove user information.

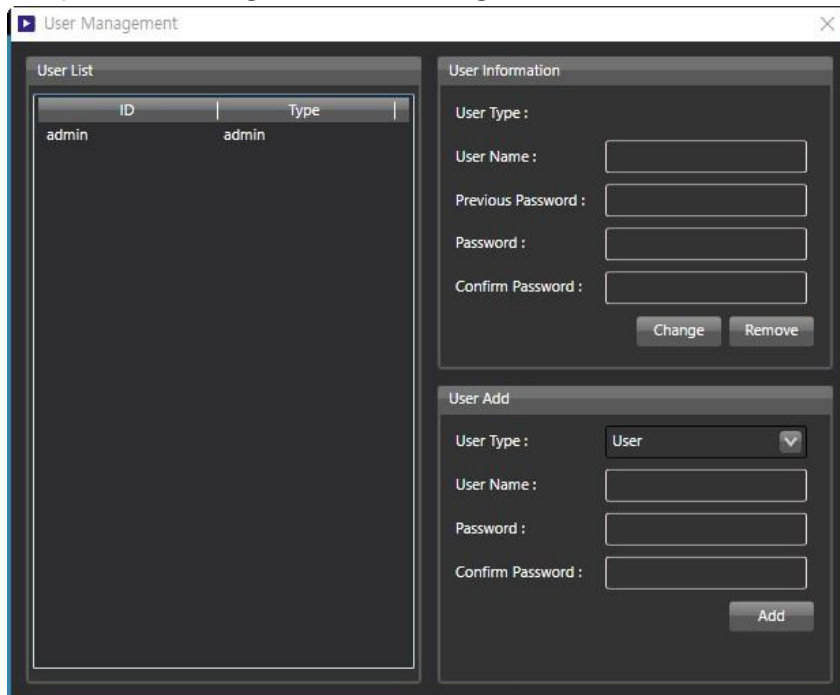

User Management

ID	Type
admin	admin

User Information

User Type :

User Name :

Previous Password :

Password :

Confirm Password :

Change Remove

User Add

User Type :

User Name :

Password :

Confirm Password :

Add

- (5) Setup > Device Setup: Set MPDS Network environment, Video Output Resolution, Reboot, Display Power or firmware upgrade.

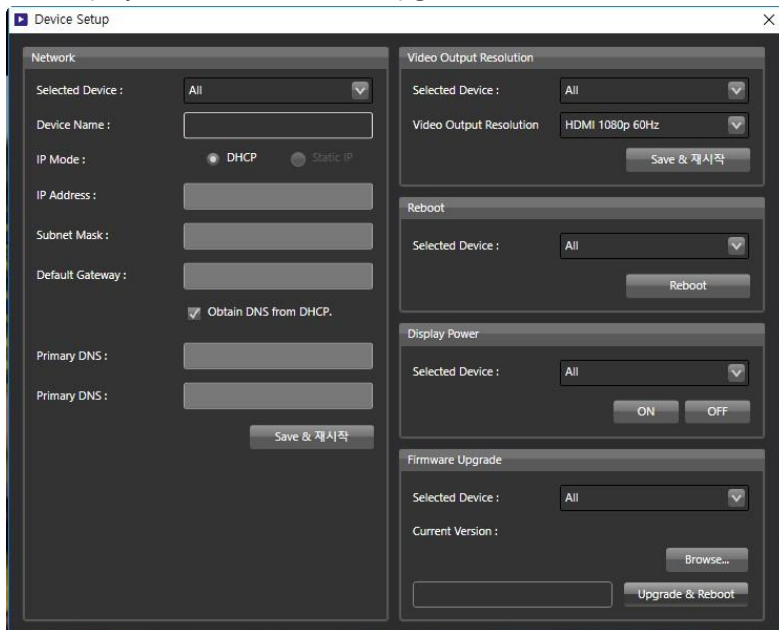

- (6) Setup > Environment Setup: Select Language, Network Interface, Shared Network Directory, Device Sorting Order. Sources (documents or video, picture, audio files) except for IP camera (encoder) will be played from shared network directory. Browse Network Attached Storage (NAS) or shared folder of PC on shared folder and type user account, password of NAS or PC then click Apply. If there is no user account use it as guest. Check user account information and password of PC that has shared network directory.

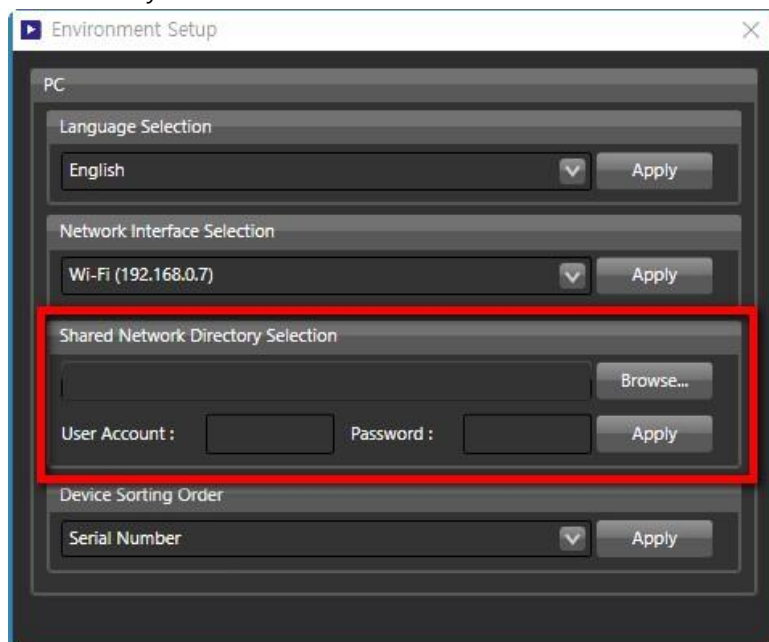

(7) Layout Template: Set display placement and assign source to the desired place.

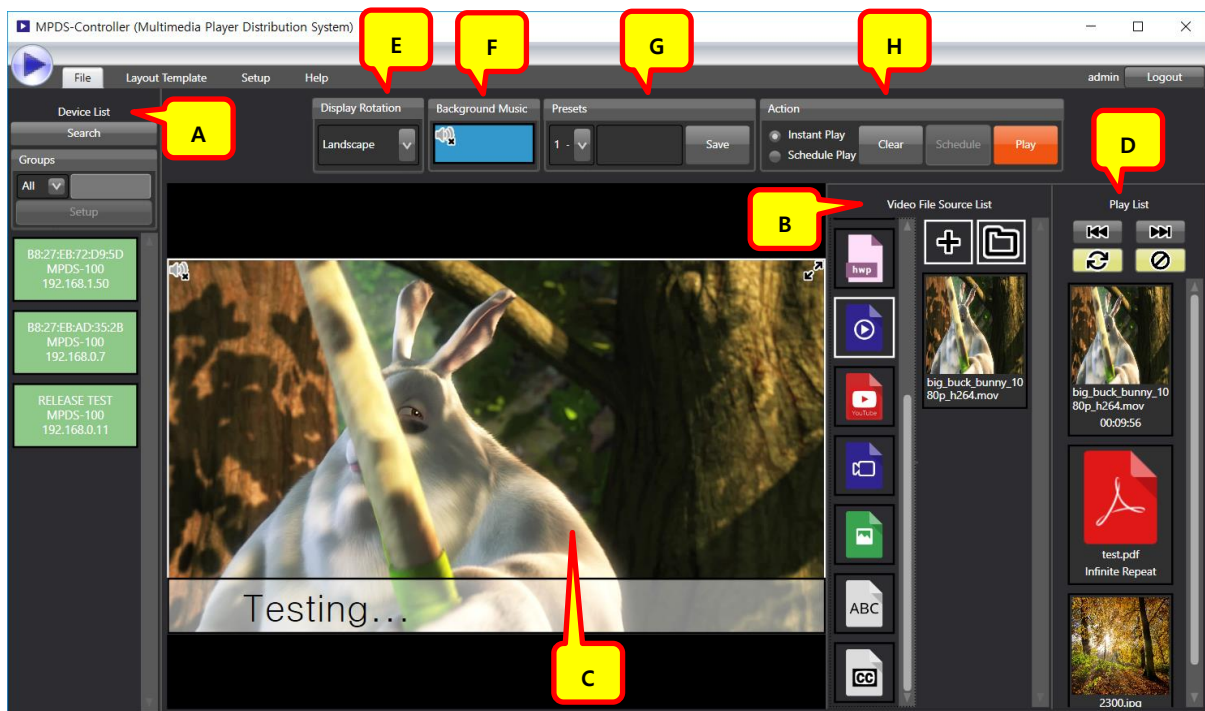

(Entire Screen Configuration)

- A. Device list
Search MPDS device list and group those sources. Device setup and reboot can be made by right click of mouse.
- B. Source list
Select source type from left icons; document, video, YouTube, IP camera (encoder), picture, text, caption. File or folder can be added with Source Add button. All sources can be deleted by right click of mouse.
- C. View Screen
Assign preview screen for desired source to the play list from source list with drag and drop of mouse. In case of divided display, divided area can be adjusted by mouse move. It can be deleted by right click of mouse.
- D. Play List
Displaying play list that is selected from view screen. Set playing time from top to bottom and change sequence of play list. Change to play previous or next

source and turn on/off play list repeat and switch effect. With right click of mouse, user can delete play list or change playing time.

E. Display Rotation

Set landscape or portrait modes depend on direction of the display (TV/Monitor). This setting will be applied after reboot of MPDS-100.

F. Background Music

Drag and drop audio file from source list to this area to list background music on the play list.

G. Presets

Save and load current view screen and play list. Presets can be saved/loaded up to 99 per group.

H. Action

Instant Play can play current view screen and play list immediately.

Schedule Play is consist of weekly scheduling and sequence scheduling. Weekly scheduling enables to play sources in preset time and days of the week, and sequence scheduling enables to play source in preset sequence.

(8) How to add document, video, picture, audio file to the source

- 1) (A) Select group. If not entire group, click setup button to assign devices.
- 2) (B) Select source type > Click source add(+) or folder add button > Select more than one file or one folder.
- 3) (C) File or folder will be place on the source list.

(9) How to add YouTube source

(C) From source list, select YouTube source and click add(+) button, then below window will pop up.

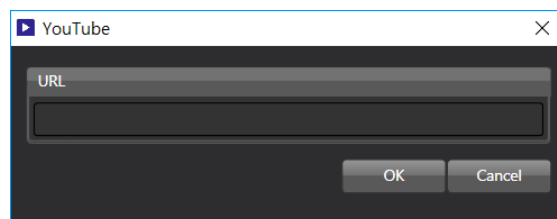

From YouTube video page, use right click of mouse to copy URL address of video, then paste them to above window and click OK. After this, video from YouTube will be downloaded and saved in shared network directory and added on (C) source list.

* URL of YouTube has to be in <https://youtu.be/XXX> format.

* It won't be added if YouTube source is not in H.264 MP4 1080p or 720p.

(10) How to add IP camera (encoder) source.

From source list(C), select IP camera (encoder) source and click add(+) button, then below window will pop up.

If you select "Searched IP camera (encoder) Add", click search button to find IP camera (encoder) list from local network. Select IP camera (encoder) need to be added from the list. If certification is needed to use IP camera (encoder), click particular IP camera (encoder) and type in user account and password and click Certify & Add button to add IP camera (encoder) on the list.

* IP camera (encoder) that doesn't support ONVIF protocol won't be shown.

If you select "Manual IP camera (encoder) Add", ONVIF Device Service Address will be filled in when typing IP address (it can be changed if there is other address). If certification is needed, type in user account and password and click 'Attempt ONVIF Request' button, then Main/Sub Stream URL will be automatically filled in.

* Main/Sub stream URL will not get filled in after clicking 'Attempt ONVIF Request' button if IP camera (encoder) that doesn't support ONVIF protocol.

If Main/Sub Stream URL is known from IP camera (encoder) manual, user can type in URL without clicking 'Attempt ONVIF Request' button.

* Device will not be added if typing wrong user account/password, or if device doesn't support H.264 1080p or 720p.

(11) How to add text source

From source list (C), select text source and click add(+) button, then below window will pop up.

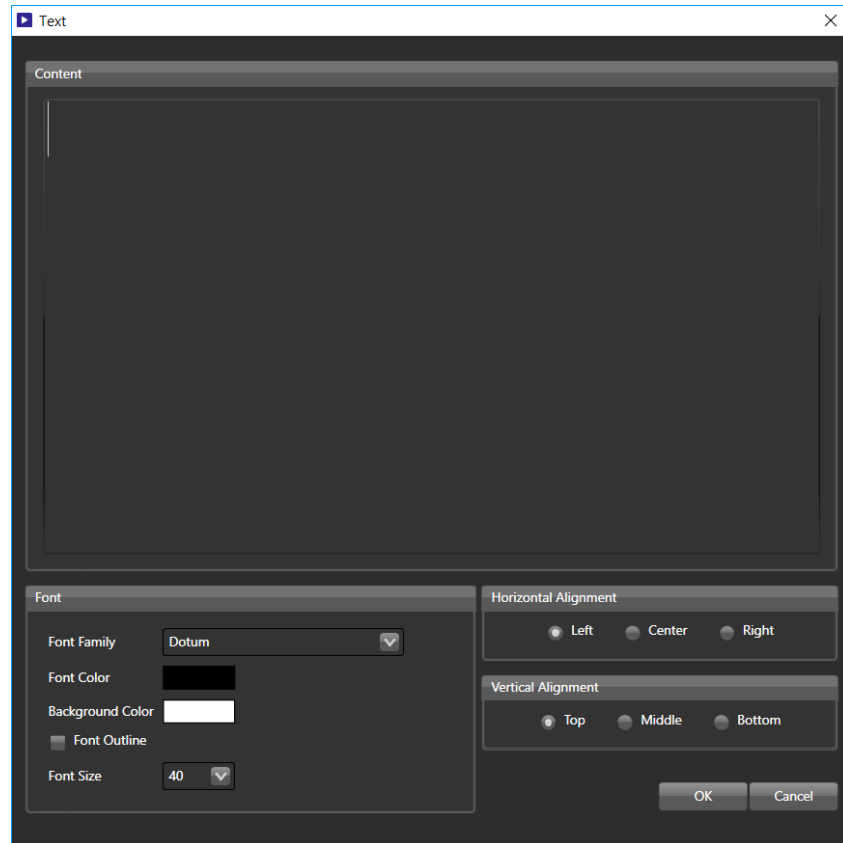

Type in contents need to be displayed on the screen under contents field, and select horizontal/vertical alignment and click 'OK' to add it on the source list (C).

* Only Fonts, installed in Windows PC, that support multiple language will be displayed in the list.

* Character will be converted into image and saved in shared network directory before displaying on the screen. MPDS does not have Windows font.

(12) How to add caption source

From source list(C), select caption and click add(+) button, then below window will pop up.

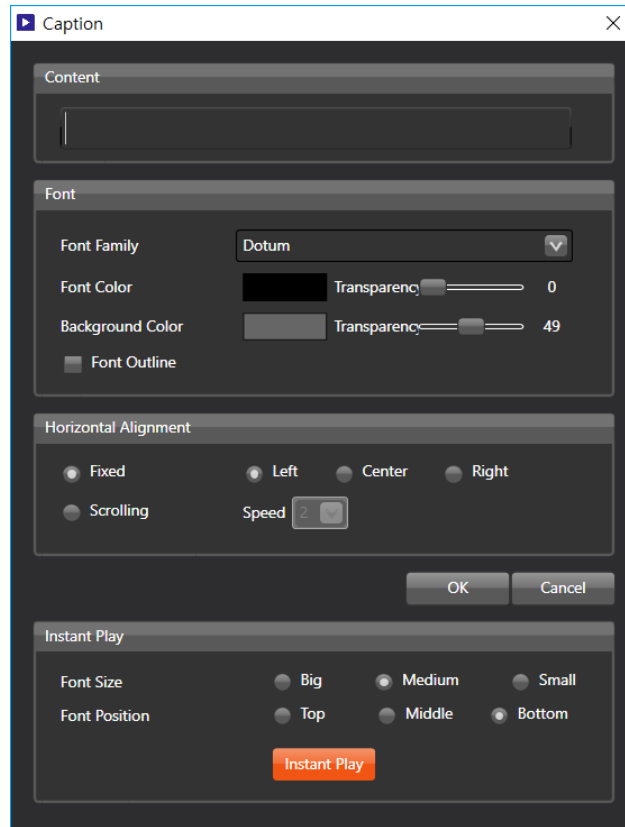

Type in contents need to be displayed on the screen under contents field, and select horizontal/vertical alignment and click 'OK' to add it on the source list (C). Caption will be displayed on the top of other sources in one line, and their size can be adjusted after adding them on the view screen.

Instant Play enables typed contents to be displayed immediately on the screen without adding it on the source list(C) to use it as notice or announcement.

* Character will be converted into image and saved in shared network directory before displaying on the screen. MPDS does not have Windows font.

(13) How to add sources on source list

- 1) Drag and drop file/folder that has added on source list(C) to view screen.
- 2) Added source(D) will be listed on playing list in order. If necessary, playing time of each source can be set.

- (14) (H) Selecting 'Instant Play' and clicking 'Play' button will start playing current view screen from play list.
- (15) To save current view screen and play list, select current screen number(G) and set its name and save.
- (16) (H) Selecting 'Schedule Play' and clicking 'Play' button will have below window pop up.

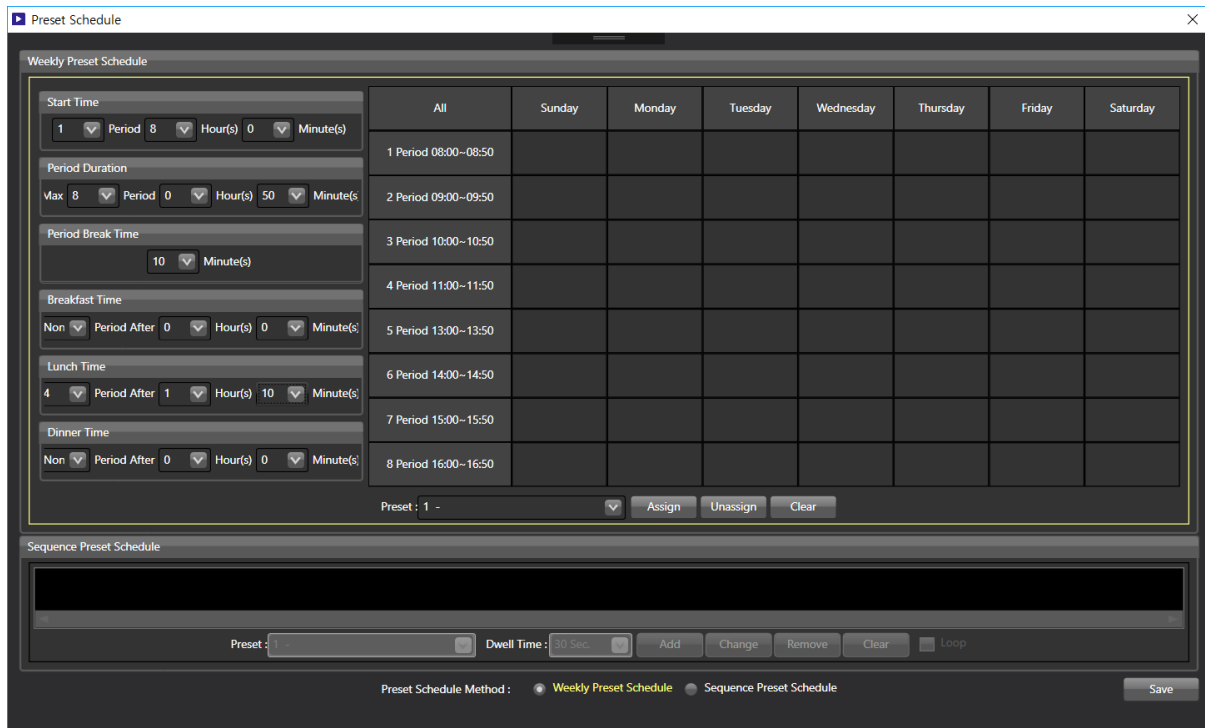

From Preset Schedule Method in the bottom, selecting Weekly Preset Schedule enables playing saved preset for days/time based.

From Preset Schedule Method in the bottom, selecting Sequence Preset Schedule enables playing saved preset as set time based in order.

Click Save button, and click Play(H) button to start schedule playing.

* If set time of MPDS-100 and PC are different, it might not be able to weekly scheduled preset in right time.

* When installing MPDS-Controller program, activate Windows Time Service and allow NTP port from firewall (UP port 123).

* When clicking 'Play' button, MPDS will start to synchronize its time with PC.

* After installing MPDS-Controller program, time synchronization could be failed if Windows Time Service gets disabled or Firewall setup changes due to user setup or windows update.

* Time of MPDS can be set manually from Setup.

7. Product Specification

- General Specification

	Description
Network	10/100 Base-TX Ethernet
Resolution	Up to 1080p@60Hz
Video Interface	HDMI 1.4
Video codec	H.264, MPEG4, VP6, VP7, VP8
Audio Interface	HDMI Audio and Analog Line-Out (Dual output)
Supported Source Type	<ul style="list-style-type: none"> * Document File : pdf, doc(x), xls(x), ppt(x), hwp. * Video File : avi, mov, mkv, mp4, etc. * Audio File : mp3, ogg, wav, etc. * Streaming: YouTube, HTTP, RTP/RTSP, etc. * Image File : bmp, jpg, gif, png, etc. * Text : Static/Scrolling Text. Font Family, Font/Background Color.
Dimension	114 x 66 x 32 mm (WDH)
Power Consumption	10W
Operating Temperature	0 ~ 40°C
Storage Temperature	-20 ~ 60°C

- Absolute Maximum Ratings

Parameter	Symbol	Minimum	Maximum	Units
Supply Adaptor Voltage, Temp=25°C	VCC	-0.3	+5.25	V
Operating Temperature	Top	0	40	°C
Operating Relative Humidity	RHop	5	80*	%RH
Storage Temperature	Tsto	- 30	+ 70	°C
Storage Relative Humidity	RHsto	10	95*	%RH

8. Warranty

1 (One) Year Warranty

Opticis warrants MPDS-100, Media Player Distribution System to be free from defects in workmanship and material, under normal use and service, for a period of one(1) year from the date of purchase from Opticis or authorized resellers.

To request repair or service from Opticis, customer shall not open the product, nor place any part of MPDS-100 without assistance from Opticis. Keep serial number sticker on the device.

Opticis has no responsibility for any software, firmware, information or memory data of customer contained in, stored on, or integrated with any returned to Opticis for repair

(Under warranty or not)

1. Free Repair

- Faulty MPDS-100 under normal use in warranty in period

2. Customer Paid Repair

- Faulty MPDS-100 but out of warranty period
- Faulty caused by negligence and/or intention of customer
- Faulty caused by voluntary alternation or repair without approval from Opticis
- Faulty caused by natural calamities
- Faulty caused by connection with other faulty device

If a product does not work as warranted during applicable warranty period, Opticis shall, at its option and expense, repair the defective product or part, deliver to customer an equivalent product or part to replace the defective item refund to purchase price for the defective product.

All products that are replaced will become the property of Opticis. Replacement products may be new or reconditioned.

Dispose of Old Electrical & Electronic Equipment

(Applicable in the European Union and other European countries with separate systems)



This symbol on the product or on its packaging indicates that this product shall not be treated as household waste. Instead it shall be handed over to the applicable collection point for the recycling of electrical and electronic equipment. By ensuring this product is disposed of correctly, you will help prevent potential negative consequences for the environment and human health, which could otherwise be caused by inappropriate waste handling of this product.

The recycling of materials will help to conserve natural resources. For more detailed information about recycling of this product, please contact your local city office, your household waste disposal service or the shop where you purchased the product.



HeadQuarter

7F, 166, Jeongjail-ro, Bundang-gu
Sungnam-si, Gyeonggi-do
13558. South Korea
Tel: +82 (31) 719-8033
Fax: +82 (31) 719-8032

Please visit Opticis website, www.opticis.com
or contact tosales@opticis.com or techsupp@opticis.com
if you need any technical support or additional support.

Direktronik AB
Konsul Johnsons väg 15
SE-149 45 Nynäshamn
Sweden

+46 8 524 00 700

info@direktronik.se
www.direktronik.se